

# Power Meter *Centrale de mesure* *Central de medida* PM850

Reference manual  
*Manual de référence*  
*Manual de referencia*

Retain for future use.





---

## NOTICE

Read these instructions carefully and look at the equipment to become familiar with the device before trying to install, operate, service, or maintain it. The following special messages may appear throughout this bulletin or on the equipment to warn of potential hazards or to call attention to information that clarifies or simplifies a procedure.



The addition of either symbol to a “Danger” or “Warning” safety label indicates that an electrical hazard exists which will result in personal injury if the instructions are not followed.



This is the safety alert symbol. It is used to alert you to potential personal injury hazards. Obey all safety messages that follow this symbol to avoid possible injury or death.

### **DANGER**

DANGER indicates an immediately hazardous situation which, if not avoided, **will result in** death or serious injury.

### **WARNING**

WARNING indicates a potentially hazardous situation which, if not avoided, **can result in** death or serious injury.

### **CAUTION**

CAUTION indicates a potentially hazardous situation which, if not avoided, **can result in** minor or moderate injury.

### **CAUTION**

CAUTION, used without the safety alert symbol, indicates a potentially hazardous situation which, if not avoided, **can result in** property damage.

*NOTE: Provides additional information to clarify or simplify a procedure.*

## PLEASE NOTE

Electrical equipment should be installed, operated, serviced, and maintained only by qualified personnel. No responsibility is assumed by Square D for any consequences arising out of the use of this manual.

---

## CLASS A FCC STATEMENT

This equipment has been tested and found to comply with the limits for a Class B digital device, pursuant to Part 15 of the FCC Rules. These limits are designed to provide reasonable protection against harmful interference in a residential installation. This equipment generates, uses and can radiate radio frequency energy and, if not installed and used in accordance with the instructions, may cause harmful interference to radio communications. However, there is no guarantee that interference will not occur in a particular installation. If this equipment does cause harmful interference to radio or television reception, which can be determined by turning the equipment off and on, the user is encouraged to try to correct the interference by one or more of the following measures:

- Reorient or relocate the receiving antenna.
- Increase the separation between the equipment and receiver.
- Connect the equipment into an outlet on a circuit different from that to which the receiver is connected.

Consult the dealer or an experienced radio/TV technician for help.

# Table of Contents

---

TABLE OF CONTENTS	..III
INTRODUCTION	1
What is the Power Meter?	1
Power Meter Hardware	2
Power Meter Parts and Accessories	3
Box Contents	3
Features	4
Firmware	4
Topics Not Covered in this Bulletin	4
SAFETY PRECAUTIONS	7
Before You Begin	7
OPERATION	9
Operating the Display	9
How the Buttons Work	9
Changing Values	10
Menu Overview	10
Set Up the Power Meter	12
Set Up Communications	12
Set Up the Date	13
Set Up the Time	13
Set Up the Language	14
Set Up CTs	14
Set Up PTs	15
Set Up the Meter System Type	15
Set Up Alarms	16
Set Up I/Os	17
Set Up the Passwords	18
Set Up the Alarm Backlight	18
Advanced Power Meter Setup Options	19
Set Up the Phase Rotation	19
Set Up the Incremental Energy Interval	20
Set Up the THD Calculation	20
Set Up the VAR/PF Convention	21
Set Up the Lock Resets	21
Power Meter Diagnostics	22
View the Meter Information	22
Check the Health Status	23
Read and Write Registers	23
METERING CAPABILITIES	25
Real-Time Readings	25

# Table of Contents

---

Min/Max Values for Real-time Readings .....	26
Power Factor Min/Max Conventions .....	27
Power Factor Sign Conventions .....	29
Demand Readings .....	30
Demand Power Calculation Methods .....	31
Block Interval Demand .....	31
Synchronized Demand .....	34
Thermal Demand .....	35
Demand Current .....	35
Predicted Demand .....	36
Peak Demand .....	36
Generic Demand .....	37
Energy Readings .....	38
Power Analysis Values .....	41
INPUT/OUTPUT CAPABILITIES .....	43
Digital Inputs .....	43
Demand Synch Pulse Input .....	44
Relay Output Operating Modes .....	45
Solid-state KY Pulse Output .....	49
2-wire Pulse Initiator .....	50
Calculating the Kilowatthour-Per-Pulse Value .....	51
ALARMS .....	53
About Alarms .....	53
Alarm Groups .....	53
Setpoint-driven Alarms .....	54
Priorities .....	56
Alarm Levels .....	57
Custom Alarms .....	58
Types of Setpoint-controlled Functions .....	58
Scale Factors .....	61
Scaling Alarm Setpoints .....	63
Alarm Conditions and Alarm Numbers .....	64
LOGGING .....	69
Introduction .....	69
Memory Allocation for Log Files .....	69
Alarm Log .....	70
Alarm Log Storage .....	70
Data Logs .....	70
Alarm-driven Data Log Entries .....	71
Organizing Data Log Files .....	71
Billing Log .....	72
Maintenance Log .....	73

# Table of Contents

---

WAVEFORM CAPTURE .....	77
Waveform Capture .....	77
Initiating a Waveform .....	77
Waveform Storage .....	77
Waveform Storage Modes .....	77
MAINTENANCE AND TROUBLESHOOTING .....	79
Introduction .....	79
Power Meter Memory .....	79
Identifying the Firmware Version, Model, and Serial Number .....	80
Viewing the Display in Different Languages .....	80
Getting Technical Support .....	81
Troubleshooting .....	82
POWER METER REGISTER LIST .....	85
About Registers .....	85
How Power Factor is Stored in the Register .....	85
How Date and Time are Stored in Registers .....	86
Register List .....	87
USING THE COMMAND INTERFACE .....	155
Overview of the Command Interface .....	155
Issuing Commands .....	156
I/O Point Numbers .....	159
Operating Outputs from the Command Interface .....	160
Using the Command Interface to Change Configuration Registers .....	160
Conditional Energy .....	161
Command Interface Control .....	162
Digital Input Control .....	163
Incremental Energy .....	164
Using Incremental Energy .....	165
Setting Up Individual Harmonic Calculations .....	167
Changing Scale Factors .....	168
INDEX .....	171

# Table of Contents

---



# Introduction

## What is the Power Meter?

### What is the Power Meter?

The power meter is a multifunction, digital instrumentation, data acquisition and control device. It can replace a variety of meters, relays, transducers and other components. The power meter can be installed at multiple locations within a facility.

The power meter is equipped with RS-485 communications for integration into any power monitoring and control system. However, System Manager™ software (SMS) from POWERLOGIC, which is written specifically for power monitoring and control, best supports the power meter's advanced features.

The power meter is a true rms meter capable of exceptionally accurate measurement of highly nonlinear loads. A sophisticated sampling technique enables accurate, true rms measurement through the 63rd harmonic. You can view over 50 metered values plus minimum and maximum data from the display or remotely using software. Table 1–1 summarizes the readings available from the power meter.

**Table 1–1: Summary of power meter Instrumentation**

Real-time Readings	Power Analysis
<ul style="list-style-type: none"> <li>• Current (per phase, residual, 3-Phase)</li> <li>• Voltage (L–L, L–N, 3-Phase)</li> <li>• Real Power (per phase, 3-Phase)</li> <li>• Reactive Power (per phase, 3-Phase)</li> <li>• Apparent Power (per phase, 3-Phase)</li> <li>• Power Factor (per phase, 3-Phase)</li> <li>• Frequency</li> <li>• Temperature (internal ambient)</li> <li>• THD (current and voltage)</li> </ul>	<ul style="list-style-type: none"> <li>• Displacement Power Factor (per phase, 3-Phase)</li> <li>• Fundamental Voltages (per phase)</li> <li>• Fundamental Currents (per phase)</li> <li>• Fundamental Real Power (per phase)</li> <li>• Fundamental Reactive Power (per phase)</li> <li>• Unbalance (current and voltage)</li> <li>• Phase Rotation</li> <li>• Harmonic Magnitudes &amp; Angles (per phase)</li> <li>• Sequence Components</li> </ul>
Energy Readings	Demand Readings
<ul style="list-style-type: none"> <li>• Accumulated Energy, Real</li> <li>• Accumulated Energy, Reactive</li> <li>• Accumulated Energy, Apparent</li> <li>• Bidirectional Readings</li> <li>• Reactive Energy by Quadrant</li> <li>• Incremental Energy</li> <li>• Conditional Energy</li> </ul>	<ul style="list-style-type: none"> <li>• Demand Current (per phase present, 3-Phase avg.)</li> <li>• Average Power Factor (3-Phase total)</li> <li>• Demand Real Power (per phase present, peak)</li> <li>• Demand Reactive Power (per phase present, peak)</li> <li>• Demand Apparent Power (per phase present, peak)</li> <li>• Coincident Readings</li> <li>• Predicted Power Demands</li> </ul>

# Introduction

## Power Meter Hardware

### Power Meter Hardware

Figure 1-1: Parts of the Power Meter 800

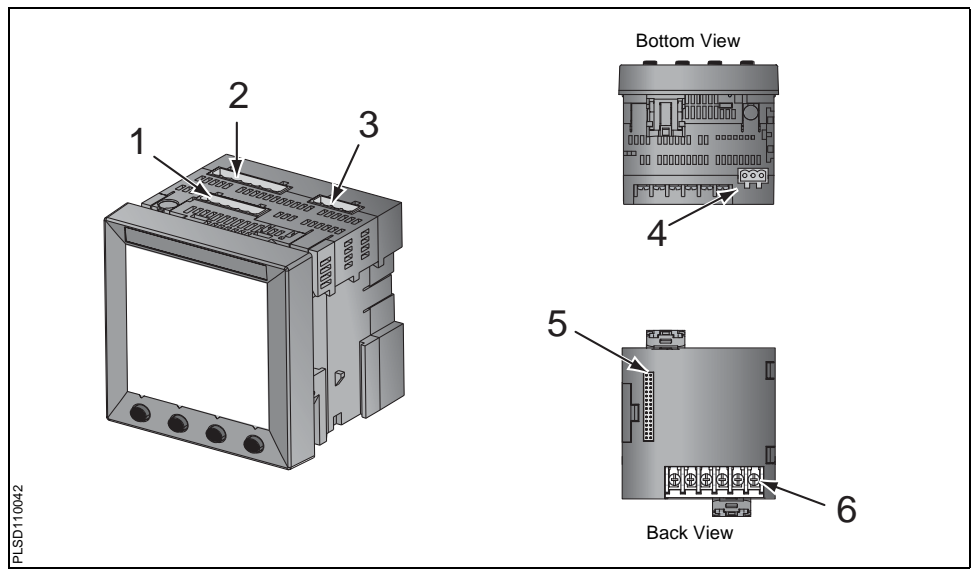

PLSD110042

# Introduction

## Power Meter Hardware

**Table 1–2: Parts of the Power Meter**

No.	Part	Description
1	Control power supply connector	Connection for control power to the power meter.
2	Voltage inputs	Voltage metering connections.
3	I/O connector	KY pulse output/digital input connections
4	RS-485 port (COM1)	The RS-485 port is used for communications with a monitoring and control system. This port can be daisy-chained to multiple devices.
5	Option module connector	Used to connect an option module to the power meter.
6	Current inputs	Current metering connections.

### Power Meter Parts and Accessories

**Table 1–3: Power Meter Parts and Accessories**

Description	Document Number
Power Meter with Integrated Display	
PM850 PM850MG	
Power Meter without Display	
PM850U PM850UMG	
Display	
PM8D PM8DMG	

### Box Contents

- Power Meter
- Hardware kit containing:
  - Two retainers
  - Template
  - Install sheet
  - Lugs
  - DIN Slide
  - Plug set

## Introduction

### Firmware

---

- Power Meter installation manual

### Features

Some of the power meter's many features include:

- True rms metering to the 63rd harmonic
- Accepts standard CT and PT inputs
- 600 volt direct connection on voltage inputs
- Certified ANSI C12.20 revenue accuracy and IEC 60687 0.5S class revenue accuracy
- High accuracy—0.075% current and voltage (typical conditions)
- Min/max readings of metered data
- Power quality readings—THD
- Real-time harmonic magnitudes and angles to the 63rd harmonic
- Downloadable firmware
- Easy setup through the integrated display (password protected)
- Setpoint-controlled alarm and relay functions
- Onboard alarm and data logging
- Wide operating temperature range:  $-25^{\circ}$  to  $+70^{\circ}\text{C}$  for the main unit,  $-10^{\circ}$  to  $50^{\circ}\text{C}$  for the display
- RS-485 communications

### Firmware

See "Identifying the Firmware Version, Model, and Serial Number" on page 80 for instructions on how to determine the firmware version.

### Topics Not Covered in this Bulletin

Some of the power meter's advanced features, such as onboard data logs and alarm log files, can only be set up over the communications link using SMS. SMS

## Introduction

### Topics Not Covered in this Bulletin

---

versions 3.3 and higher support the PM800 device type. This power meter instruction bulletin describes these advanced features, but does not tell how to set them up. For instructions on using SMS, refer to the SMS online help and the *SMS-3000 Setup Guide*, which is available in English, French, and Spanish. For information about related instruction bulletins, see Table 1–3 on page 3.

# Introduction

Topics Not Covered in this Bulletin

---

## Safety Precautions

### Before You Begin

#### Before You Begin

This chapter contains important safety precautions that must be followed before attempting to install, service, or maintain electrical equipment. Carefully read and follow the safety precautions outlined below.

### DANGER

#### HAZARD OF ELECTRIC SHOCK, BURN, OR EXPLOSION

- Only qualified workers should install this equipment. Such work should be performed only after reading this entire set of instructions.
- NEVER work alone.
- Before performing visual inspections, tests, or maintenance on this equipment, disconnect all sources of electric power. Assume that all circuits are live until they have been completely de-energized, tested, and tagged. Pay particular attention to the design of the power system. Consider all sources of power, including the possibility of backfeeding.
- Turn off all power supplying this equipment before working on or inside.
- Always use a properly rated voltage sensing device to confirm that all power is off.
- Beware of potential hazards, wear personal protective equipment, carefully inspect the work area for tools and objects that may have been left inside the equipment.
- Use caution while removing or installing panels so that they do not extend into the energized bus; avoid handling the panels, which could cause personal injury.
- The successful operation of this equipment depends upon proper handling, installation, and operation. Neglecting fundamental installation requirements may lead to personal injury as well as damage to electrical equipment or other property.
- Before performing Dielectric (Hi-Pot) or Megger testing on any equipment in which the power meter is installed, disconnect all input and output wires to the power meter. High voltage testing may damage electronic components contained in the power meter.

**Failure to follow this instruction will result in death or serious injury**

## Safety Precautions Before You Begin

---



## Operation

### Operating the Display

#### Operating the Display

The power meter is equipped with a large, back-lit LCD display. It can display up to five lines of information plus a sixth row of menu options. Figure 3–1 shows the different parts of the power meter.

Figure 3–1: Power Meter Display

- A. Type of measurement
- B. Screen Title
- C. Alarm indicator
- D. Maintenance icon
- E. Bar Chart (%)
- F. Units
- G. Display more menu items
- H. Menu item
- I. Selected menu indicator
- J. Button
- K. Return to previous menu
- L. Values
- M. Phase

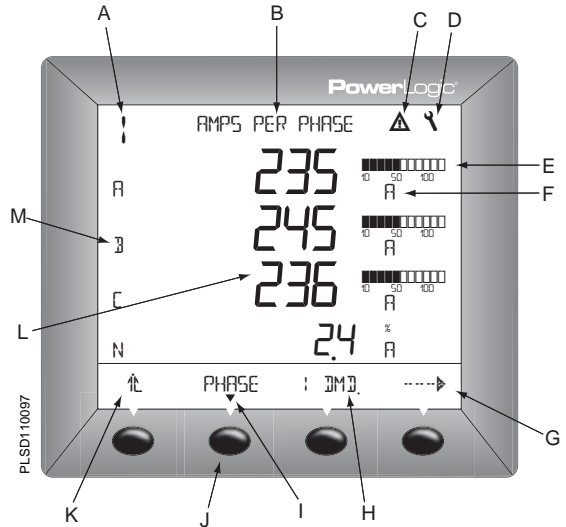

#### How the Buttons Work

The buttons are used to select menu items, display more menu items in a menu list, and return to previous menus. A menu item appears over one of the four buttons. Pressing a button selects the menu item and displays the menu item's screen. When you have reached the highest menu level, a black triangle appears beneath the selected menu item. To return to the previous menu level, press the button below  $\uparrow$ . To cycle through the menu items in a menu list, press the button below  $\rightarrow$  (see Figure 3–1).

**NOTE:** Each time you read “press” in this manual, press and release the appropriate button beneath the

## Operation

### Menu Overview

---

*menu item. For example, if you are asked to “Press PHASE,” you would press the button below the PHASE menu item.*

#### Changing Values

When a value is selected, it flashes to indicate that it can be modified. A value is changed by doing the following:

- Press + or – to change numbers or scroll through available options.
- If you are entering more than one number, press ← to move to the next number in the sequence.
- To save your changes and move to the next field, press OK.

### Menu Overview

The figure below shows the menu items of the first two levels of the power meter. Level 1 contains all of the menu items available on the first screen of the power meter. Selecting a Level 1 menu item takes you to the next screen level containing the Level 2 menu items.

*NOTE: The  is used to scroll through all menu items on a level.*

# Operation

## Menu Overview

Figure 3–2: Abbreviated List of Power Meter Menu Items

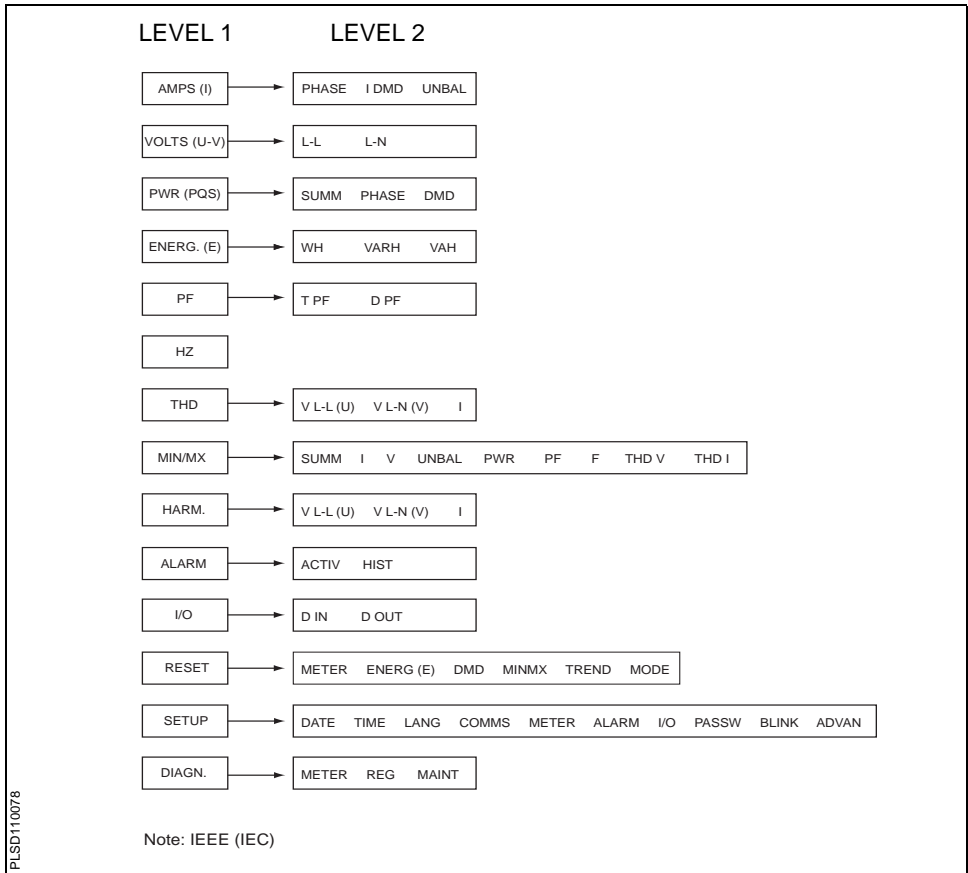

## Operation

### Set Up the Power Meter

#### Set Up the Power Meter

To begin power meter setup, do the following:



1. Scroll through the Level 1 menu list until you see SETUP.
2. Press SETUP.
3. Enter your password.

*NOTE: The default password is 0000.*

4. To save the changes, press  until you are prompted to save the changes.

Follow the directions in the following sections to set up the meter.

#### Set Up Communications

1. Press  until COMMS is visible.
2. Press COMMS.
3. Select the communications protocol: MBUS (MODBUS) or JBUS
4. Press OK.
5. Enter the ADDR (meter address).
6. Press OK.
7. Select the BAUD (baud rate): 9600, 19200, or 38400.
8. Press OK.
9. Select how the parity: EVEN, ODD, NONE.
10. Press  to return to the SETUP screen.

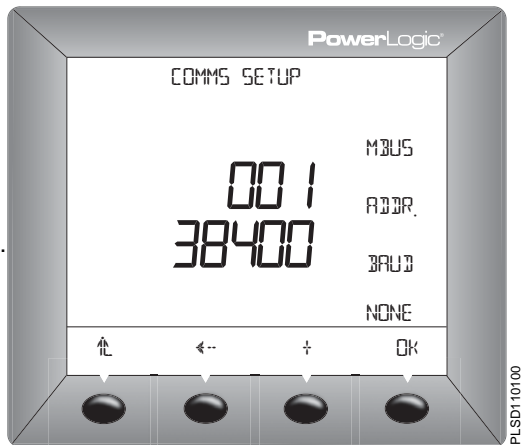

## Operation

### Set Up the Power Meter

#### Set Up the Date

1. Press  $\rightarrow$  until DATE is visible.
2. Press DATE.
3. Enter the MONTH number.
4. Press OK.
5. Enter the DATE number.
6. Press OK.
7. Enter the YEAR number.
8. Press OK.
9. Select how the date is displayed: M/D/Y, D/M/Y, or Y/M/D.
10. Press  $\uparrow$  to return to the SETUP screen.

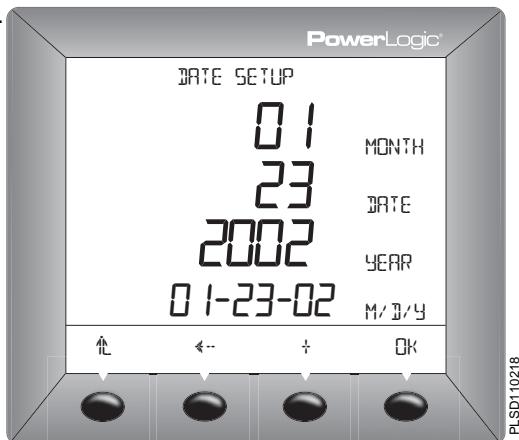

#### Set Up the Time

1. Press  $\rightarrow$  until TIME is visible.
2. Press TIME.
3. Enter the HOUR.
4. Press OK.
5. Enter the MIN (minutes).
6. Press OK.
7. Enter the SEC (seconds).
8. Press OK.
9. Select how the time is displayed: 24H or AM/PM.
10. Press  $\uparrow$  to return to the SETUP screen.

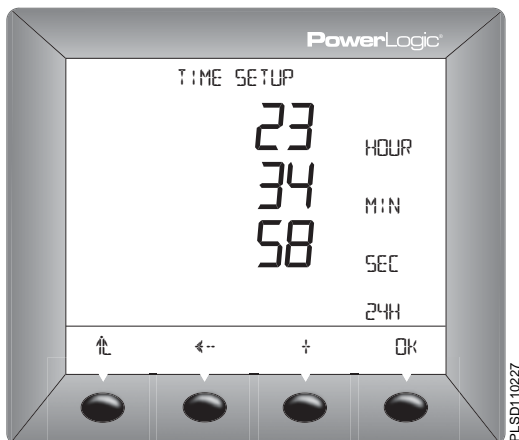

## Operation

### Set Up the Power Meter

#### Set Up the Language

1. Press  $\rightarrow$  until LANG is visible.
2. Press LANG (language).
3. Select the language: ENGL (English), SPAN (Spanish), FREN (French).
4. Press  $\uparrow$  to return to the SETUP screen.



#### Set Up CTs

1. Press  $\rightarrow$  until METER is visible.
2. Press METER.
3. Press CT.
4. Enter the PRIM CT (primary CT) number.
5. Press OK.
6. Enter the SECON. CT (secondary CT) number.
7. Press OK.
8. Press  $\uparrow$  to return to the METER SETUP screen.
9. Press  $\uparrow$  to return to the SETUP screen.

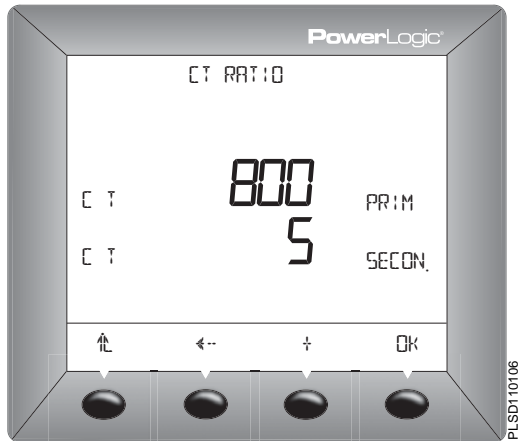

## Operation

### Set Up the Power Meter

#### Set Up PTs

1. Press  $\rightarrow$  until METER is visible.
2. Press METER.
3. Press PT.
4. Enter the SCALE value: x1, x10, x100, NO PT (for direct connect).
5. Press OK.
6. Enter the PRIM (primary) value.
7. Press OK.
8. Enter the SEC. (secondary) value.
9. Press OK.
10. Press  $\uparrow$  to return to the METER SETUP screen.
11. Press  $\uparrow$  to return to the SETUP screen.
12. Press  $\uparrow$  to save the changes.

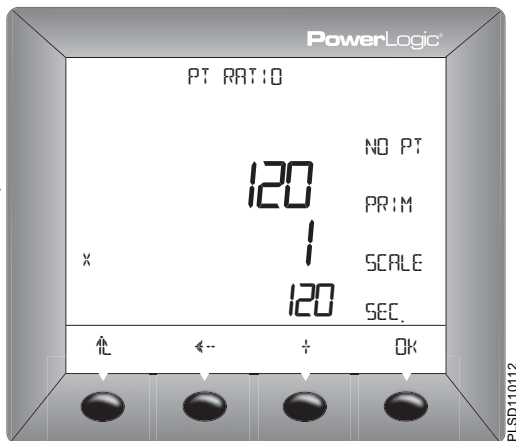

#### Set Up the Meter System Type

1. Press  $\rightarrow$  until METER is visible.
2. Press METER.
3. Press SYS.
4. Select the SYS (system type).
5. Press OK.
6. Select the FREQ (frequency).
7. Press OK.
8. Press  $\uparrow$  to return to the METER SETUP screen.
9. Press  $\uparrow$  to return to the SETUP screen.

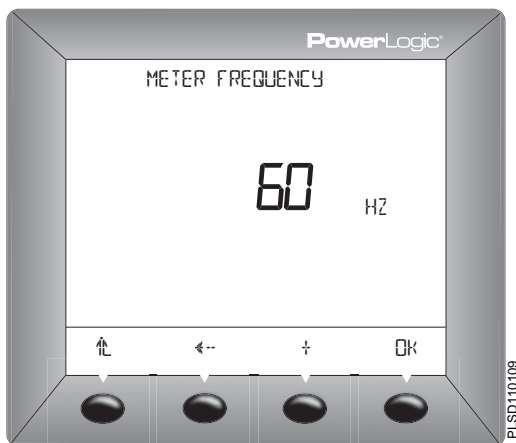

## Operation

### Set Up the Power Meter

#### Set Up Alarms

1. Press  $\leftarrow$  until ALARM is visible.
2. Press ALARM.
3. Press  $\leftarrow$  or  $\rightarrow$  to select the alarm you want to edit.
4. Press EDIT.
5. Select to enable or disable the alarm: ENABL (enable) or DISAB (disable).
6. Press OK.
7. Select the PR (priority): NONE, HIGH, MED, or LOW.
8. Press OK.
9. Enter the PU VALUE (pick-up value).
10. Press OK.
11. Enter the PU DELAY (pick-up delay).
12. Press OK.
13. Enter the DO VALUE (drop-out value).
14. Press OK.
15. Enter the DO DELAY (drop-out delay).
16. Press OK.
17. Press  $\uparrow$  to return to the alarm summary screen.
18. Press  $\uparrow$  to return to the SETUP screen.

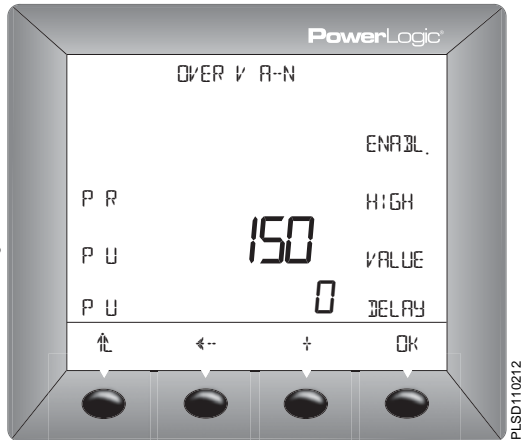



## Operation

### Set Up the Power Meter

#### Set Up I/Os

1. Press  $\leftarrow$  until I/O is visible.
2. Press I/O.
3. Press  $\leftarrow$  or  $\rightarrow$  to select the I/O.
4. Press EDIT.
5. Select the I/O mode based on the I/O type and the user selected mode: NORM., LATCH, TIMED, PULSE, or END OF
6. Depending on the mode selected, the power meter will prompt you to enter the pulse weight, timer, and control.
7. Press OK.
8. Press  $\uparrow$  to return to the I/O screen.
9. Press  $\uparrow$  to return to the SETUP screen.

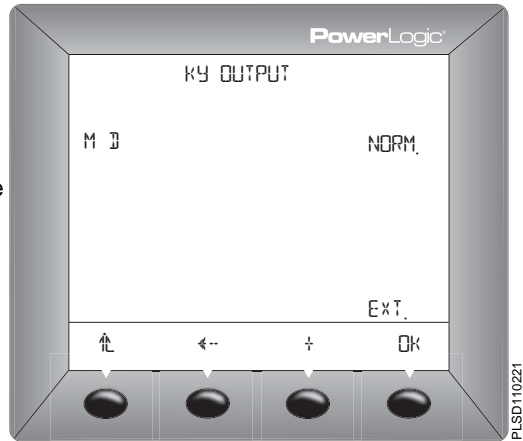

## Operation

### Set Up the Power Meter

#### Set Up the Passwords

1. Press  $\leftarrow$  until PASSW (password) is visible.
2. Press PASSW.
3. Enter the SETUP password.
4. Press OK.
5. Enter the DIAG (diagnostics) password.
6. Press OK.
7. Enter the ENERG (energy reset) password.
8. Press OK.
9. Enter the MINMX (minimum/maximum reset) password.
10. Press OK.
11. Press  $\uparrow$  to return to the SETUP screen.

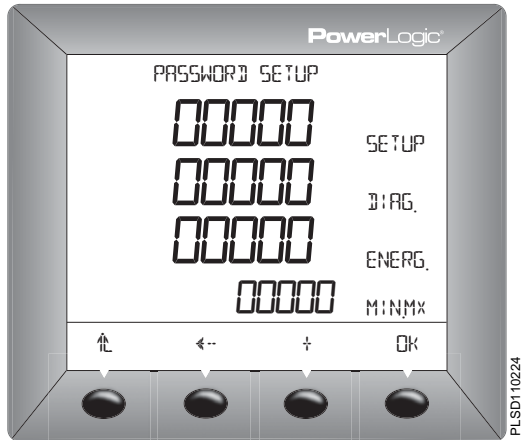

#### Set Up the Alarm Backlight

1. Press  $\leftarrow$  until BLINK is visible.
2. Press BLINK.
3. Enter ON or OFF.
4. Press  $\uparrow$  to return to the SETUP screen.



## Operation

### Advanced Power Meter Setup Options

#### Advanced Power Meter Setup Options

To setup the advanced power meter options, do the following:

1. Scroll through the Level 1 menu list until you see SETUP.
2. Press SETUP.
3. Enter your password.

*NOTE: The default password is 0000.*

4. Press  $\leftarrow$  until ADVAN (advanced setup) is visible.
5. Press ADVAN.

Follow the directions in the following sections to set up the meter.

#### Set Up the Phase Rotation

1. Press  $\leftarrow$  until ROT (phase rotation) is visible.
2. Press ROT.
3. Select the phase rotation: ABC or CBA.
4. Press  $\uparrow$  to return to the SETUP screen.

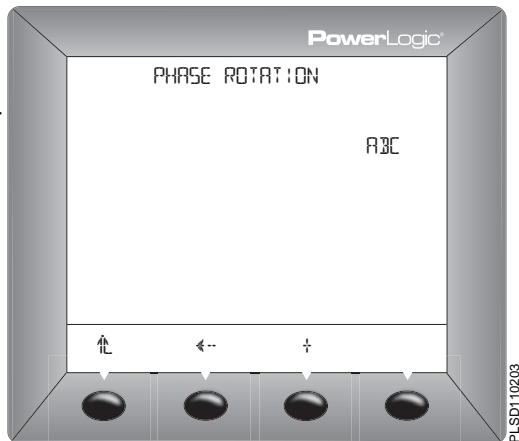

## Operation

### Advanced Power Meter Setup Options

#### Set Up the Incremental Energy Interval

1. Press  $\rightarrow$  until E-INC is visible.
2. Press E-INC (incremental energy).
3. Enter the INTVL (interval). Range is 00 to 60.
4. Press  $\uparrow$  to return to the SETUP screen.

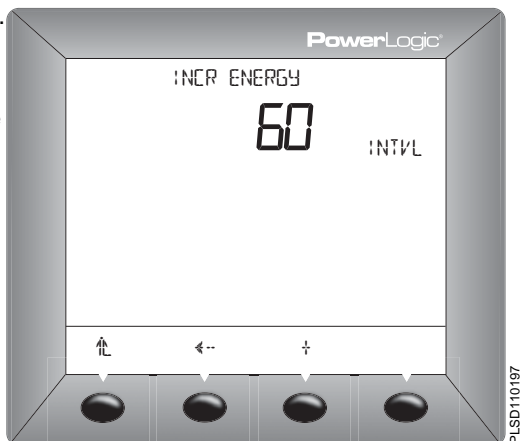

PLSD110197

#### Set Up the THD Calculation

1. Press  $\rightarrow$  until THD is visible.
2. Press THD.
3. Select the THD calculation: FUND or RMS.
4. Press  $\uparrow$  to return to the SETUP screen.

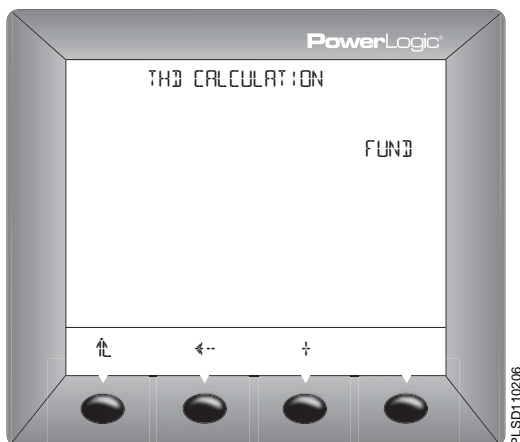

PLSD110206

## Operation

### Advanced Power Meter Setup Options

#### Set Up the VAR/PF Convention

1. Press  $\rightarrow$  until PF is visible.
2. Press PF.
3. Select the Var/PF convention: IEEE or IEC.
4. Press  $\uparrow$  to return to the SETUP screen.



#### Set Up the Lock Resets

1. Press  $\rightarrow$  until LOCK is visible.
2. Press LOCK.
3. Select Y (yes) or N (no) to enable or disable resets for PK.DMD, ENERG, MN/MX, and METER.
4. Press  $\uparrow$  to return to the SETUP screen.

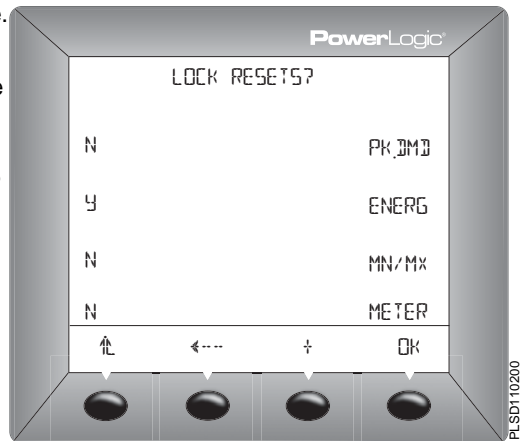

## Operation

### Power Meter Diagnostics

#### Power Meter Diagnostics

To begin viewing the power meter's model, firmware version, serial number, read and write registers, or check the health status, do the following:

1. Scroll through the Level 1 menu list until you see DIAGN (diagnostics).
2. Press DIAGN.
3. Enter your password.

*NOTE: The default password is 0000.*

Follow the directions in the following sections:

#### View the Meter Information

1. Press METER (meter info).
2. View the meter information.
3. Press --> to view more meter information.
4. Press ↑ to return to the DIAGNOSTICS screen.

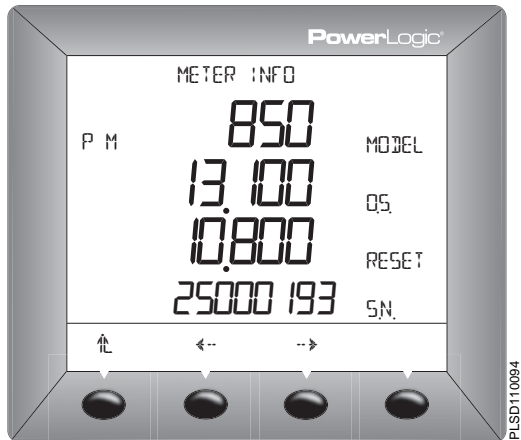

## Operation

### Power Meter Diagnostics

#### Check the Health Status

1. Press MAINT. (maintenance).
2. The health status is displayed on the screen.
3. Press  $\uparrow$  to return to the DIAGNOSTICS screen.

*NOTE: The wrench icon and the health status code displays when a health problem is detected. For code 1, set up the Date/Time (see "Set Up the Date" and "Set Up the Time" on page 13). For other codes, contact technical support.*



#### Read and Write Registers

1. Press REG (register).
2. Enter the REG. (register) number.

The HEX (hexadecimal) and DEC (decimal) values of the register number you entered displays.

3. Press OK.
4. Enter the DEC number if necessary.
5. Press  $\uparrow$  to return to the DIAGNOSTICS screen.

*NOTE: For more information about using registers, see **Appendix A—Power Meter Register List** on page 85.*

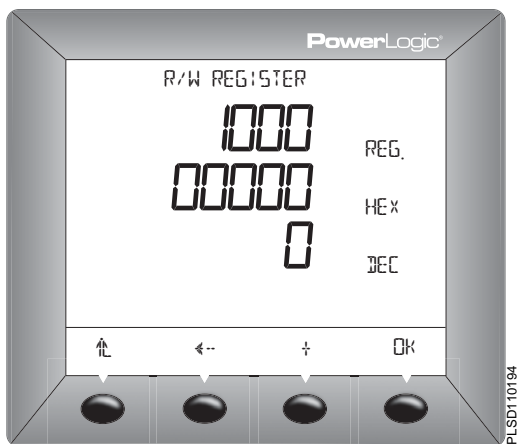

## Operation

### Power Meter Diagnostics

---



# Metering Capabilities

## Real-Time Readings

### Real-Time Readings

The power meter measures currents and voltages and reports in real time the rms values for all three phases and neutral. In addition, the power meter calculates power factor, real power, reactive power, and more.

Table 4–1 lists some of the real-time readings that are updated every second along with their reportable ranges.

**Table 4–1: One-second, Real-time Readings**

Real-time Readings	Reportable Range
<b>Current</b>	
Per-Phase	0 to 32,767 A
Neutral	0 to 32,767 A
3-Phase Average	0 to 32,767 A
Apparent rms	0 to 32,767 A
% Unbalance	0 to $\pm 100.0\%$
<b>Voltage</b>	
Line-to-Line, Per-Phase	0 to 1,200 kV
Line-to-Line, 3-Phase Average	0 to 1,200 kV
Line-to-Neutral, Per-Phase	0 to 1,200 kV
Line-to-Neutral, 3-Phase Average	0 to 1,200 kV
% Unbalance	0 to 100.0%
<b>Real Power</b>	
Per-Phase	0 to $\pm 3,276.70$ MW
3-Phase Total	0 to $\pm 3,276.70$ MW
<b>Reactive Power</b>	
Per-Phase	0 to $\pm 3,276.70$ MVAR
3-Phase Total	0 to $\pm 3,276.70$ MVAR
<b>Apparent Power</b>	
Per-Phase	0 to $\pm 3,276.70$ MVA
3-Phase Total	0 to $\pm 3,276.70$ MVA
<b>Power Factor (True)</b>	
Per-Phase	-0.002 to 1.000 to +0.002
3-Phase Total	-0.002 to 1.000 to +0.002

## Metering Capabilities

### Min/Max Values for Real-time Readings

**Table 4-1: One-second, Real-time Readings**

Real-time Readings	Reportable Range
<b>Power Factor (Displacement)</b>	
Per-Phase	-0.002 to 1.000 to +0.002
3-Phase Total	-0.002 to 1.000 to +0.002
<b>Frequency</b>	
45-65 Hz	23.00 to 67.00 Hz
350-450 Hz	350.00 to 450.00 Hz

### Min/Max Values for Real-time Readings

When certain one-second real-time readings reach their highest or lowest value, the Power Meter saves the values in its nonvolatile memory. These values are called the minimum and maximum (min/max) values.

The Power Meter stores the min/max values for the current month and previous month. After the end of each month, the Power Meter moves the current month's min/max values into the previous month's register space and resets the current month's min/max values. The current month's min/max values can be reset manually at any time using the Power Meter display or SMS. After the min/max values are reset, the Power Meter records the date and time. The real-time readings evaluated are:

- Min/Max Voltage L-L
- Min/Max Voltage L-N
- Min/Max Current
- Min/Max Voltage L-L, Unbalance
- Min/Max Voltage L-N, Unbalance
- Min/Max Total True Power Factor
- Min/Max Total Displacement Power Factor
- Min/Max Real Power Total
- Min/Max Reactive Power Total
- Min/Max Apparent Power Total

## Metering Capabilities

### Power Factor Min/Max Conventions

---

- Min/Max THD/thd Voltage L-L
- Min/Max THD/thd Voltage L-N
- Min/Max THD/thd Current
- Min/Max Frequency

For each min/max value listed above, the following attributes are recorded by the Power Meter:

- Date/Time of minimum value
- Minimum value
- Phase of recorded minimum value
- Date/Time of maximum value
- Maximum value
- Phase of recorded maximum value

*NOTE: Phase of recorded min/max only applies to multi-phase quantities.*

*NOTE: There are a couple of ways to view the min/max values. The Power Meter display can be used to view the min/max values since the meter was last reset. Using SMS, an instantaneous table with the current month's and previous month's min/max values can be viewed.*

### Power Factor Min/Max Conventions

All running min/max values, except for power factor, are arithmetic minimum and maximum values. For example, the minimum phase A-B voltage is the lowest value in the range 0 to 1200 kV that has occurred since the min/max values were last reset. In contrast, because the power factor's midpoint is unity (equal to one), the power factor min/max values are not true arithmetic minimums and maximums. Instead, the minimum value represents the measurement closest to -0 on a continuous scale for all real-time readings -0 to 1.00 to +0. The maximum value is the measurement closest to +0 on the same scale.

## Metering Capabilities

### Power Factor Min/Max Conventions

Figure 4–1 below shows the min/max values in a typical environment in which a positive power flow is assumed. In the figure, the minimum power factor is -0.7 (lagging) and the maximum is 0.8 (leading). Note that the minimum power factor need not be lagging, and the maximum power factor need not be leading. For example, if the power factor values ranged from -0.75 to -0.95, then the minimum power factor would be -0.75 (lagging) and the maximum power factor would be -0.95 (lagging). Both would be negative. Likewise, if the power factor ranged from +0.9 to +0.95, the minimum would be +0.95 (leading) and the maximum would be +0.90 (leading). Both would be positive in this case.

**Figure 4–1: Power factor min/max example**

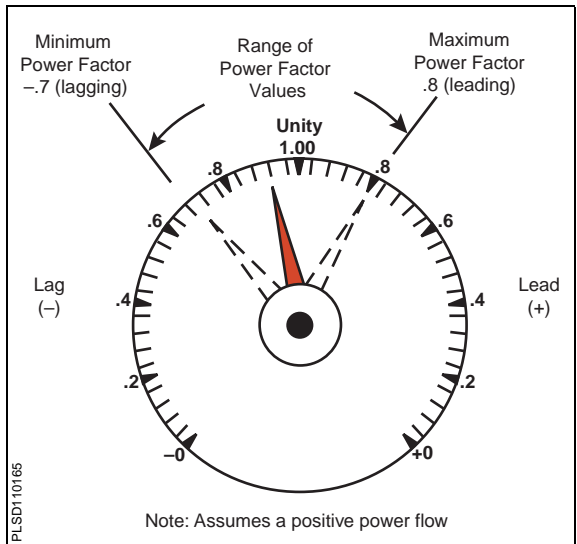

An alternate power factor storage method is also available for use with analog outputs and trending. See the footnotes in “Register List” on page 87 for the applicable registers.

# Metering Capabilities

## Power Factor Sign Conventions

### Power Factor Sign Conventions

The power meter can be set to one of two power factor sign conventions: IEEE or IEC. The Series 800 Power Meter defaults to the IEEE power factor sign convention. Figure 4–2 illustrates the two sign conventions. For instructions on changing the power factor sign convention, refer to “Advanced Power Meter Setup Options” on page 19.

Figure 4–2: Power factor sign convention

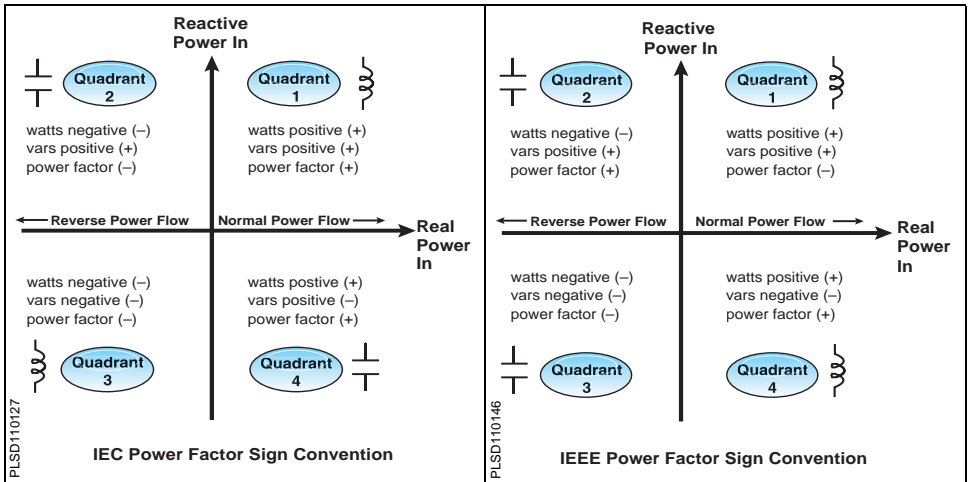

# Metering Capabilities

## Demand Readings

The power meter provides a variety of demand readings, including coincident readings and predicted demands. Table 4–2 lists the available demand readings and their reportable ranges.

Table 4–2: Demand Readings

Demand Readings	Reportable Range
<b>Demand Current, Per-Phase, 3Ø Average, Neutral</b>	
Last Complete Interval	0 to 32,767 A
Peak	0 to 32,767 A
<b>Average Power Factor (True), 3Ø Total</b>	
Last Complete Interval	–0.002 to 1.000 to +0.002
Coincident with kW Peak	–0.002 to 1.000 to +0.002
Coincident with kVAR Peak	–0.002 to 1.000 to +0.002
Coincident with kVA Peak	–0.002 to 1.000 to +0.002
<b>Demand Real Power, 3Ø Total</b>	
Last Complete Interval	0 to ± 3276.70 MW
Predicted	0 to ± 3276.70 MW
Peak	0 to ± 3276.70 MW
Coincident kVA Demand	0 to ± 3276.70 MVA
Coincident kVAR Demand	0 to ± 3276.70 MVAR
<b>Demand Reactive Power, 3Ø Total</b>	
Last Complete Interval	0 to ± 3276.70 MVAR
Predicted	0 to ± 3276.70 MVAR
Peak	0 to ± 3276.70 MVAR
Coincident kVA Demand	0 to ± 3276.70 MVA
Coincident kW Demand	0 to ± 3276.70 MW
<b>Demand Apparent Power, 3Ø Total</b>	
Last Complete Interval	0 to ± 3276.70 MVA
Predicted	0 to ± 3276.70 MVA
Peak	0 to ± 3276.70 MVA
Coincident kW Demand	0 to ± 3276.70 MW
Coincident kVAR Demand	0 to ± 3276.70 MVAR

# Metering Capabilities

## Demand Readings

---

### Demand Power Calculation Methods

Demand power is the energy accumulated during a specified period divided by the length of that period. How the power meter performs this calculation depends on the method you select. To be compatible with electric utility billing practices, the power meter provides the following types of demand power calculations:

- Block Interval Demand
- Synchronized Demand
- Thermal Demand

The default demand calculation is set to sliding block with a 15 minute interval. You can set up any of the demand power calculation methods from SMS. See the SMS online help to perform the set up using the software.

#### Block Interval Demand

In the block interval demand method, you select a “block” of time that the power meter uses for the demand calculation. You choose how the power meter handles that block of time (interval). Three different modes are possible:

- **Sliding Block.** In the sliding block interval, you select an interval from 1 to 60 minutes (in 1-minute increments). If the interval is between 1 and 15 minutes, the demand calculation *updates every 15 seconds*. If the interval is between 16 and 60 minutes, the demand calculation *updates every 60 seconds*. The power meter displays the demand value for the last completed interval.
- **Fixed Block.** In the fixed block interval, you select an interval from 1 to 60 minutes (in 1-minute increments). The power meter calculates and updates the demand at the end of each interval.
- **Rolling Block.** In the rolling block interval, you select an interval and a subinterval. The subinterval must divide evenly into the interval. For example, you might set three 5-minute

## Metering Capabilities

### Demand Readings

---

subintervals for a 15-minute interval. Demand is *updated at each subinterval*. The power meter displays the demand value for the last completed interval.

Figure 4–3 below illustrates the three ways to calculate demand power using the block method. For illustration purposes, the interval is set to 15 minutes.



# Metering Capabilities

## Demand Readings

Figure 4-3: Block Interval Demand Examples

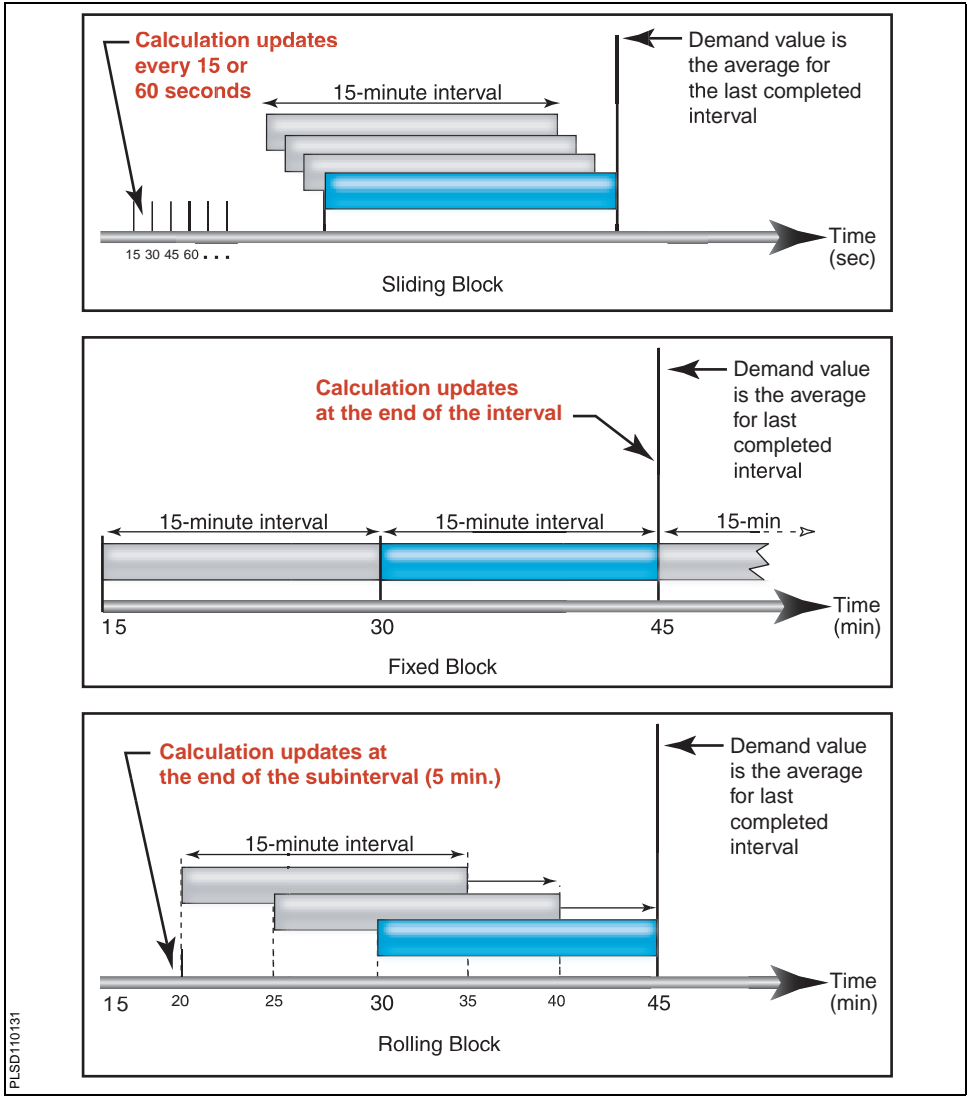

## Metering Capabilities

### Demand Readings

---

#### Synchronized Demand

The demand calculations can be synchronized by accepting an external pulse input, a command sent over communications, or by synchronizing to the internal real-time clock.

- **Input Synchronized Demand.** You can set up the power meter to accept an input such as a demand synch pulse from an external source. The power meter then uses the same time interval as the other meter for each demand calculation. You can use the standard digital input installed on the meter to receive the synch pulse. When setting up this type of demand, you select whether it will be input-synchronized block or input-synchronized rolling block demand. The rolling block demand requires that you choose a subinterval.
- **Command Synchronized Demand.** Using command synchronized demand, you can synchronize the demand intervals of multiple meters on a communications network. For example, if a PLC input is monitoring a pulse at the end of a demand interval on a utility revenue meter, you could program the PLC to issue a command to multiple meters whenever the utility meter starts a new demand interval. Each time the command is issued, the demand readings of each meter are calculated for the same interval. When setting up this type of demand, you select whether it will be command-synchronized block or command-synchronized rolling block demand. The rolling block demand requires that you choose a subinterval. See **Appendix B—Using the Command Interface** on page 155 for more information.
- **Clock Synchronized Demand.** You can synchronize the demand interval to the internal real-time clock in the power meter. This enables you to synchronize the demand to a particular time, typically on the hour. The default time is 12:00 am. If you select another time of day when the demand intervals are to be synchronized, the time must be in minutes from midnight. For

## Metering Capabilities

### Demand Readings

example, to synchronize at 8:00 am, select 480 minutes. When setting up this type of demand, you select whether it will be clock-synchronized block or clock-synchronized rolling block demand. The rolling block demand requires that you choose a subinterval.

#### Thermal Demand

The thermal demand method calculates the demand based on a thermal response, which mimics thermal demand meters. The demand calculation updates at the end of each interval. You select the demand interval from 1 to 60 minutes (in 1-minute increments). In Figure 4–4 the interval is set to 15 minutes for illustration purposes.

**Figure 4–4: Thermal Demand Example**

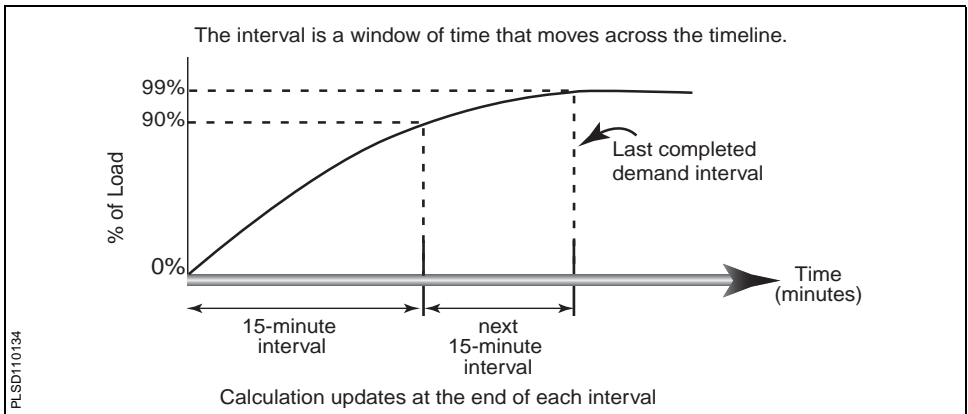

#### Demand Current

The power meter calculates demand current using the thermal demand method. The default interval is 15 minutes, but you can set the demand current interval between 1 and 60 minutes in 1-minute increments.

## Metering Capabilities

### Demand Readings

#### Predicted Demand

The power meter calculates predicted demand for the end of the present interval for kW, kVAR, and kVA demand. This prediction takes into account the energy consumption thus far within the present (partial) interval and the present rate of consumption. The prediction is updated every second.

Figure 4–5 illustrates how a change in load can affect predicted demand for the interval.

Figure 4–5: Predicted Demand Example

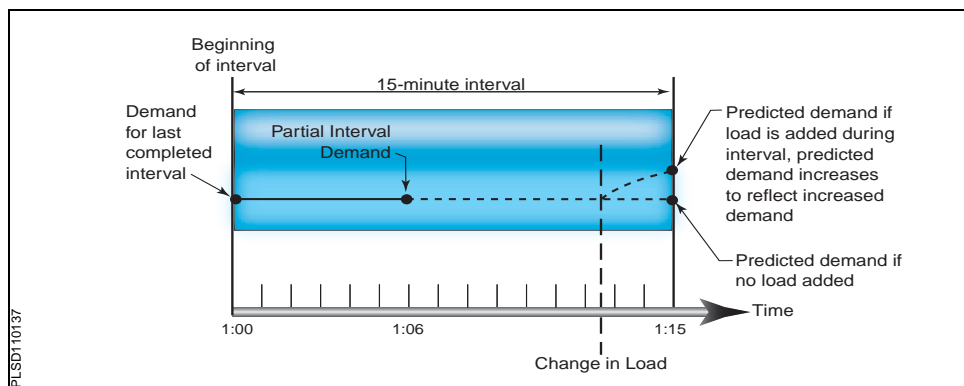

#### Peak Demand

In nonvolatile memory, the power meter maintains a running maximum for power demand values, called “peak demand.” The peak is the highest average for each of these readings: kW, kVAR, and kVA since the last reset. The power meter also stores the date and time when the peak demand occurred. In addition to the peak demand, the power meter also stores the coinciding average 3-phase power factor. The average 3-phase power factor is defined as “demand kW/demand kVA” for the peak demand interval. Table 4–2 on page 30 lists the available peak demand readings from the power meter.

You can reset peak demand values from the power meter display. From the Main Menu, select Resets >

## Metering Capabilities

### Demand Readings

---

Demand. You can also reset the values over the communications link by using SMS. See the SMS online help for instructions.

*NOTE: You should reset peak demand after changes to basic meter setup, such as CT ratio or system type.*

The power meter also stores the peak demand during the last incremental energy interval. See “Energy Readings” on page 38 for more about incremental energy readings.

### Generic Demand

The power meter can perform any of the demand calculation methods, described earlier in this chapter, on up to 10 quantities that you choose. For generic demand, you do the following in SMS:

- **Select the demand calculation method** (thermal, block interval, or synchronized).
- **Select the demand interval** (from 5–60 minutes in 1–minute increments) and select the demand subinterval (if applicable).
- **Select the quantities** on which to perform the demand calculation. You must also select the units and scale factor for each quantity.

Use the Device Setup > Basic Setup tab in SMS to create the generic demand profiles. For each quantity in the demand profile, the power meter stores four values:

- Partial interval demand value
- Last completed demand interval value
- Minimum values (date and time for each is also stored)
- Peak demand value (date and time for each is also stored)

## Metering Capabilities

### Energy Readings

You can reset the minimum and peak values of the quantities in a generic demand profile by using one of two methods:

- Use SMS (see the SMS online help file), or
- Use the command interface.  
Command 5115 resets the generic demand profile. See **Appendix B—Using the Command Interface** on page 155 for more about the command interface.

### Energy Readings

The power meter calculates and stores accumulated energy values for real and reactive energy (kWh and kVARh) both into and out of the load, and also accumulates absolute apparent energy. Table 4–3 lists the energy values the power meter can accumulate.

Table 4–3: Energy Readings

Energy Reading, 3-Phase	Reportable Range	Shown on the Display
<b>Accumulated Energy</b>		
Real (Signed/Absolute) ①	-9,999,999,999,999,999 to 9,999,999,999,999,999 Wh	0000.000 kWh to 99,999.99 MWh and 0000.000 to 99,999.99 MVARh
Reactive (Signed/Absolute) ①	-9,999,999,999,999,999 to 9,999,999,999,999,999 VARh	
Real (In)	0 to 9,999,999,999,999,999 Wh	
Real (Out) ①	0 to 9,999,999,999,999,999 Wh	
Reactive (In)	0 to 9,999,999,999,999,999 VARh	
Reactive (Out) ①	0 to 9,999,999,999,999,999 VARh	
Apparent	0 to 9,999,999,999,999,999 VAh	
<b>Accumulated Energy, Conditional</b>		
Real (In) ①	0 to 9,999,999,999,999,999 Wh	Not shown on the display. Readings are obtained only through the communications link.
Real (Out) ①	0 to 9,999,999,999,999,999 Wh	
Reactive (In) ①	0 to 9,999,999,999,999,999 VARh	
Reactive (Out) ①	0 to 9,999,999,999,999,999 VARh	
Apparent ①	0 to 9,999,999,999,999,999 VAh	

## Metering Capabilities

### Energy Readings

Table 4–3: Energy Readings

Accumulated Energy, Incremental		
Real (In) ①	0 to 999,999,999,999 Wh	Not shown on the display. Readings are obtained only through the communications link.
Real (Out) ①	0 to 999,999,999,999 Wh	
Reactive (In) ①	0 to 999,999,999,999 VARh	
Reactive (Out) ①	0 to 999,999,999,999 VARh	
Apparent ①	0 to 999,999,999,999 VAh	
Reactive Energy		
Quadrant 1 ①	0 to 999,999,999,999 VARh	Not shown on the display. Readings are obtained only through the communications link.
Quadrant 2 ①	0 to 999,999,999,999 VARh	
Quadrant 3 ①	0 to 999,999,999,999 VARh	
Quadrant 4 ①	0 to 999,999,999,999 VARh	
① Not shown on the power meter display.		

The power meter can accumulate the energy values shown in Table 4–3 in one of two modes: signed or unsigned (absolute). In signed mode, the power meter considers the direction of power flow, allowing the magnitude of accumulated energy to increase and decrease. In unsigned mode, the power meter accumulates energy as a positive value, regardless of the direction of power flow. In other words, the energy value increases, even during reverse power flow. The default accumulation mode is unsigned.

You can view accumulated energy from the display. The resolution of the energy value will automatically change through the range of 000.000 kWh to 000,000 MWh (000.000 to 000,000 MVARh), or it can be fixed. See **Appendix A—Power Meter Register List** on page 85 for the contents of the registers.

For conditional accumulated energy readings, you can set the real, reactive, and apparent energy accumulation to OFF or ON when a particular condition occurs. You can do this over the communications link using a command, or from a digital input change. For example, you may want to track accumulated energy values during a particular process that is controlled by a PLC. The power meter

## Metering Capabilities

### Energy Readings

stores the date and time of the last reset of conditional energy in nonvolatile memory.

Also, the power meter provides an additional energy reading that is only available over the communications link:

- Four-quadrant reactive accumulated energy readings.** The power meter accumulates reactive energy (kVARh) in four quadrants as shown in Figure 4–6. The registers operate in unsigned (absolute) mode in which the power meter accumulates energy as positive.

Figure 4–6: Reactive energy accumulates in four quadrants

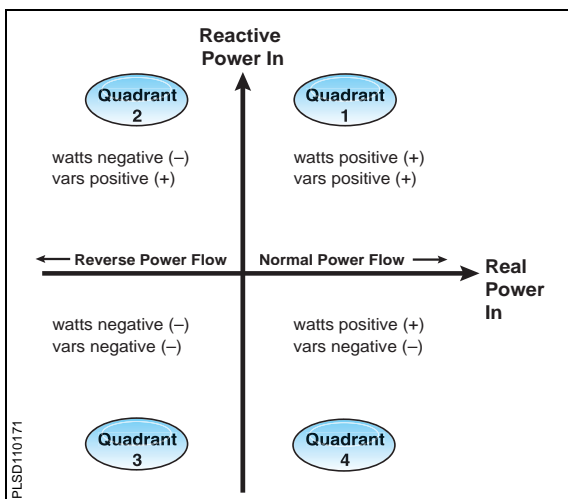



## Metering Capabilities

### Power Analysis Values

#### Power Analysis Values

The power meter provides a number of power analysis values that can be used to detect power quality problems, diagnose wiring problems, and more. Table 4–4 on page 42 summarizes the power analysis values.

- **THD.** Total Harmonic Distortion (THD) is a quick measure of the total distortion present in a waveform and is the ratio of harmonic content to the fundamental. It provides a general indication of the “quality” of a waveform. THD is calculated for both voltage and current. The power meter uses the following equation to calculate THD where H is the harmonic distortion:

$$\text{THD} = \frac{\sqrt{H_2^2 + H_3^2 + H_4^2 + \dots}}{H_1} \times 100\%$$

- **thd.** An alternate method for calculating Total Harmonic Distortion, used widely in Europe. It considers the total harmonic current and the total rms content rather than fundamental content in the calculation. The power meter calculates thd for both voltage and current. The power meter uses the following equation to calculate thd where H is the harmonic distortion:

$$\text{thd} = \frac{\sqrt{H_2^2 + H_3^2 + H_4^2 + \dots}}{\text{Total rms}} \times 100\%$$

- **Displacement Power Factor.** Power factor (PF) represents the degree to which voltage and current coming into a load are out of phase. Displacement power factor is based on the angle between the fundamental components of current and voltage.

## Metering Capabilities

### Power Analysis Values

- Harmonic Values.** Harmonics can reduce the capacity of the power system. The power meter determines the individual per-phase harmonic magnitudes and angles through the 63rd harmonic for all currents and voltages. The harmonic magnitudes can be formatted as either a percentage of the fundamental (default), a percentage of the rms value, or the actual rms value. Refer to “Setting Up Individual Harmonic Calculations” on page 167 for information on how to configure harmonic calculations.

Table 4–4: Power Analysis Values

Value	Reportable Range
<b>THD—Voltage, Current</b>	
3-phase, per-phase, neutral	0 to 3,276.7%
<b>thd—Voltage, Current</b>	
3-phase, per-phase, neutral	0 to 3,276.7%
<b>Fundamental Voltages (per phase)</b>	
Magnitude	0 to 1,200 kV
Angle	0.0 to 359.9°
<b>Fundamental Currents (per phase)</b>	
Magnitude	0 to 32,767 A
Angle	0.0 to 359.9°
<b>Miscellaneous</b>	
Fundamental Real Power (per phase, 3-phase) ①	0 to 32,767 kW
Fundamental Reactive Power (per phase) ①	0 to 32,767 kVAR
Displacement P.F. (per phase, 3-phase)	–0.002 to 1.000 to +0.002
Phase Rotation	ABC or CBA
Unbalance (current and voltage) ①	0.0 to 100.0%
Individual Harmonic Magnitudes ②	0 to 327.67%
Individual Harmonic Angles ②	0.0° to 359.9°
① Readings are obtained only through communications.	
② Harmonic Magnitude and Angles 2, 3, 4, 5, 6, 7, 8, 9, and 13 are shown on the display.	

# Input/Output Capabilities

## Digital Inputs

---

### Digital Inputs

The power meter can accept one digital input. A digital input is used to detect digital signals. For example, the digital input can be used to determine circuit breaker status, count pulses, or count motor starts. The digital input can also be associated with an external relay. You can log digital input transitions as events in the power meter's on-board alarm log. The event is date and time stamped with resolution to the second. The power meter counts OFF-to-ON transitions for each input, and you can reset this value using the command interface.

The digital input has three operating modes:

- **Normal**—Use the normal mode for simple on/off digital inputs. In normal mode, digital inputs can be used to count KY pulses for demand and energy calculation.
- **Demand Interval Synch Pulse**—you can configure any digital input to accept a demand synch pulse from a utility demand meter (see “Demand Synch Pulse Input” on page 44 of this chapter for more about this topic). For each demand profile, you can designate only one input as a demand synch input.
- **Conditional Energy Control**—you can configure one digital input to control conditional energy (see “Energy Readings” on page 38 in **Chapter 4—Metering Capabilities** for more about conditional energy).

*NOTE: By default, the digital input is named DIG IN 502 and is set up for normal mode.*

For custom setup, use SMS to define the name and operating mode of the digital input. The name is a 16-character label that identifies the digital input. The operating mode is one of those listed above. See the SMS online help for instructions on device set up of the power meter.

## Input/Output Capabilities

### Demand Synch Pulse Input

---

#### Demand Synch Pulse Input

You can configure the power meter to accept a demand synch pulse from an external source such as another demand meter. By accepting demand synch pulses through a digital input, the power meter can make its demand interval “window” match the other meter’s demand interval “window.” The power meter does this by “watching” the digital input for a pulse from the other demand meter. When it sees a pulse, it starts a new demand interval and calculates the demand for the preceding interval. The power meter then uses the same time interval as the other meter for each demand calculation. Figure 5–1 illustrates this point. See “Synchronized Demand” on page 34 in **Chapter 4—Metering Capabilities** for more about demand calculations.

When in demand synch pulse operating mode, the power meter will not start or stop a demand interval without a pulse. The maximum allowable time between pulses is 60 minutes. If 66 minutes (110% of the demand interval) pass before a synch pulse is received, the power meter throws out the demand calculations and begins a new calculation when the next pulse is received. Once in synch with the billing meter, the power meter can be used to verify peak demand charges.

Important facts about the power meter’s demand synch feature are listed below:

- Any installed digital input can be set to accept a demand synch pulse.
- Each system can choose whether to use an external synch pulse, but only one demand synch pulse can be brought into the meter for each demand system. One input can be used to synchronize any combination of the demand systems.
- The demand synch feature can be set up from SMS. See the SMS online help for instructions on device set up of the power meter.

## Input/Output Capabilities

### Relay Output Operating Modes

Figure 5–1: Demand synch pulse timing

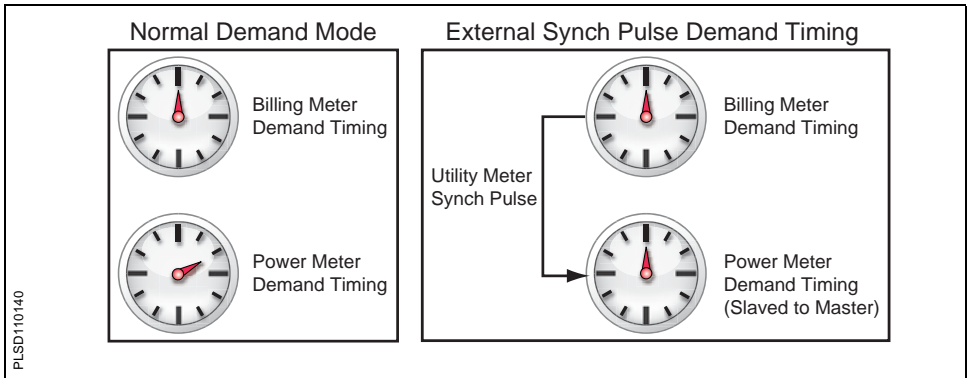

## Relay Output Operating Modes

Before we describe the 11 available relay operating modes, it is important to understand the difference between a relay configured for remote (external) control and a relay configured for power meter (internal) control.

The relay output defaults to external control, but you can choose whether the relay is set to external or internal control:

- **Remote (external) control**—the relay is controlled either from a PC using SMS or a programmable logic controller using commands via communications.
- **Power meter (internal) control**—the relay is controlled by the power meter in response to a set-point controlled alarm condition, or as a pulse initiator output. Once you've set up a relay for power meter control, you can no longer operate the relay remotely. However, you can temporarily override the relay, using SMS.

*NOTE: If any basic setup parameters or I/O setup parameters are modified, all relay outputs will be de-energized.*

## Input/Output Capabilities

### Relay Output Operating Modes

---

The 11 relay operating modes are as follows:

- **Normal**
  - *Remotely Controlled:* Energize the relay by issuing a command from a remote PC or programmable controller. The relay remains energized until a command to de-energize is issued from the remote PC or programmable controller, or until the power meter loses control power. When control power is restored, the relay is not automatically re-energized.
  - *Power Meter Controlled:* When an alarm condition assigned to the relay occurs, the relay is energized. The relay is not de-energized until *all* alarm conditions assigned to the relay have dropped out, the power meter loses control power, or the alarms are over-ridden using SMS software. If the alarm condition is still true when the power meter regains control power, the relay will be re-energized.
- **Latched**
  - *Remotely Controlled:* Energize the relay by issuing a command from a remote PC or programmable controller. The relay remains energized until a command to de-energize is issued from a remote PC or programmable controller, or until the power meter loses control power. When control power is restored, the relay will not be re-energized.
  - *Power Meter Controlled:* When an alarm condition assigned to the relay occurs, the relay is energized. The relay remains energized—even after all alarm conditions assigned to the relay have dropped out—until a command to de-energize is issued from a remote PC or programmable controller, until the high priority alarm log is cleared from the display, or until the power meter loses control power. When control power is restored, the

## Input/Output Capabilities

### Relay Output Operating Modes

---

relay will not be re-energized if the alarm condition is not TRUE.

- **Timed**

- *Remotely Controlled:* Energize the relay by issuing a command from a remote PC or programmable controller. The relay remains energized until the timer expires, or until the power meter loses control power. If a new command to energize the relay is issued before the timer expires, the timer restarts. If the power meter loses control power, the relay will not be re-energized when control power is restored and the timer will reset to zero and begin timing again.
- *Power Meter Controlled:* When an alarm condition assigned to the relay occurs, the relay is energized. The relay remains energized for the duration of the timer. When the timer expires, the relay will de-energize and remain de-energized. If the relay is on and the power meter loses control power, the relay will not be re-energized when control power is restored and the timer will reset to zero and begin timing again.

- **End Of Power Demand Interval**

This mode assigns the relay to operate as a synch pulse to another device. The output operates in timed mode using the timer setting and turns on at the end of a power demand interval. It turns off when the timer expires.

- **Absolute kWh Pulse**

This mode assigns the relay to operate as a pulse initiator with a user-defined number of kWh per pulse. In this mode, both forward and reverse real energy are treated as additive (as in a tie circuit breaker).

- **Absolute kVARh Pulse**

This mode assigns the relay to operate as a pulse initiator with a user-defined number of kVARh per pulse. In this mode, both forward and reverse

## Input/Output Capabilities

### Relay Output Operating Modes

---

reactive energy are treated as additive (as in a tie circuit breaker).

- **kVAh Pulse**

This mode assigns the relay to operate as a pulse initiator with a user-defined number of kVAh per pulse. Since kVA has no sign, the kVAh pulse has only one mode.

- **kWh In Pulse**

This mode assigns the relay to operate as a pulse initiator with a user-defined number of kWh per pulse. In this mode, only the kWh flowing into the load is considered.

- **kVARh In Pulse**

This mode assigns the relay to operate as a pulse initiator with a user-defined number of kVARh per pulse. In this mode, only the kVARh flowing into the load is considered.

- **kWh Out Pulse**

This mode assigns the relay to operate as a pulse initiator with a user-defined number of kWh per pulse. In this mode, only the kWh flowing out of the load is considered.

- **kVARh Out Pulse**

This mode assigns the relay to operate as a pulse initiator with a user-defined number of kVARh per pulse. In this mode, only the kVARh flowing out of the load is considered.

The last seven modes in the list above are for pulse initiator applications. All Series 800 Power Meters are equipped with one solid-state KY pulse output rated at 100 mA. The solid-state KY output provides the long life—billions of operations—required for pulse initiator applications.

The KY output is factory configured with Name = KY, Mode = Normal, and Control = External. To set up custom values, press SETUP > I/O. For detailed instructions, see “Set Up I/Os” on page 17. Then



## Input/Output Capabilities

### Solid-state KY Pulse Output

---

using SMS, you must define the following values for each mechanical relay output:

- **Name**—A 16-character label used to identify the digital output.
- **Mode**—Select one of the operating modes listed above.
- **Pulse Weight**—You must set the pulse weight, the multiplier of the unit being measured, if you select any of the pulse modes (last 7 listed above).
- **Timer**—You must set the timer if you select the timed mode or end of power demand interval mode (in seconds).
- **Control**—You must set the relay to be controlled either remotely or internally (from the power meter) if you select the normal, latched, or timed mode.

For instructions on setting up digital I/Os in SMS, see the SMS online help on device set up of the power meter.

### Solid-state KY Pulse Output

This section describes the pulse output capabilities of the power meter. For instructions on wiring the KY pulse output, see “Wiring the Solid-State KY Output” in Chapter 5—Wiring of the installation manual.

The power meter is equipped with one solid-state KY pulse output. The solid-state relays provides the extremely long life—billions of operations—required for pulse initiator applications.

The KY output is a Form-A contact with a maximum rating of 100 mA. Because most pulse initiator applications feed solid-state receivers with low burdens, this 100 mA rating is adequate for most applications.

# Input/Output Capabilities

## Solid-state KY Pulse Output

To set the kilowatt-hour-per-pulse value, use SMS or the display. When setting the kWh/pulse value, set the value based on a 2-wire pulse output. For instructions on calculating the correct value, see “Calculating the Kilowatt-hour-Per-Pulse Value” on page 51 in this chapter.

The KY pulse output can be configured to operate in one of 11 operating modes. See “Relay Output Operating Modes” on page 45 for a description of the modes.

### 2-wire Pulse Initiator

Figure 5–2 shows a pulse train from a 2-wire pulse initiator application.

Figure 5–2: Two-wire pulse train

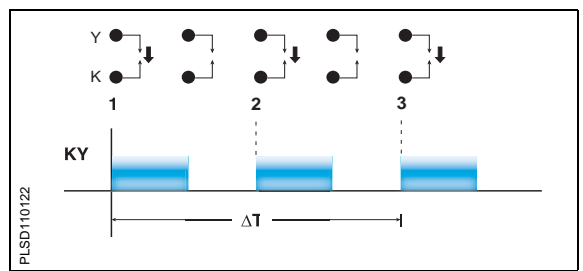

In Figure 5–2, the transitions are marked as 1 and 2. Each transition represents the time when the relay contact closes. Each time the relay transitions, the receiver counts a pulse. The power meter can deliver up to 12 pulses per second in a 2-wire application.

## Input/Output Capabilities

### Calculating the Kilowatthour-Per-Pulse Value

#### Calculating the Kilowatthour-Per-Pulse Value

This section shows an example of how to calculate kilowatthours per pulse. To calculate this value, first determine the highest kW value you can expect and the required pulse rate. In this example, the following assumptions are made:

- The metered load should not exceed 1600 kW.
- About two KY pulses per second should occur at full scale.

**Step 1:** Convert 1600 kW load into kWh/second.

$$(1600 \text{ kW}) (1 \text{ Hr}) = 1600 \text{ kWh}$$

$$\frac{(1600 \text{ kWh})}{1 \text{ hour}} = \frac{\text{"X" kWh}}{1 \text{ second}}$$

$$\frac{(1600 \text{ kWh})}{3600 \text{ seconds}} = \frac{\text{"X" kWh}}{1 \text{ second}}$$

$$X = 1600/3600 = 0.4444 \text{ kWh/second}$$

**Step 2:** Calculate the kWh required per pulse.

$$\frac{0.4444 \text{ kWh/second}}{2 \text{ pulses/second}} = 0.2222 \text{ kWh/pulse}$$

**Step 3:** Adjust for the KY initiator (KY will give one pulse per two transitions of the relay).

$$\frac{0.2222 \text{ kWh/second}}{2} = 0.1111 \text{ kWh/pulse}$$

**Step 4:** Round to nearest hundredth, since the power meter only accepts 0.01 kWh increments.

$$K_e = 0.11 \text{ kWh/pulse}$$

## Input/Output Capabilities

Calculating the Kilowatt-hour-Per-Pulse Value

---

# Alarms

## About Alarms

---

### About Alarms

The power meter can detect over 50 alarm conditions, including over or under conditions, digital input changes, phase unbalance conditions, and more. It also maintains a counter for each alarm to keep track of the total number of occurrences. A complete list of default alarm configurations are described in Table 6–3 on page 65. In addition, you can set up your own custom alarms.

When one or more alarm conditions are true, the power meter will execute a task automatically. A  icon appears in the upper-right corner of the power meter display, indicating that an alarm is active. Using SMS or the display, you can set up each alarm condition to force data log entries in up to 3 user-defined data log files. See **Chapter 7—Logging** on page 69 for more about data logging.

### Alarm Groups

Whether you are using a default alarm or creating a custom alarm, you first choose the alarm group that is appropriate for the application. Each alarm condition is assigned to one of these alarm groups:

- **Standard**—Standard alarms have a detection rate of 1 second and are useful for detecting conditions such as over current and under voltage. Up to 40 alarms can be set up in this alarm group.
- **Digital**—Digital alarms are triggered by an exception such as the transition of a digital input or the end of an incremental energy interval. Up to 12 alarms can be set up in this group.
- **Boolean**—Boolean alarms use Boolean logic to combine up to four enabled alarms. You can choose from the Boolean logic operands: AND, NAND, OR, NOR, or XOR to combine your alarms. Up to 10 alarms can be set up in this group.

## Alarms

### About Alarms

---

SMS can be used to configure any alarm types within the Series 800 Power Meters. The PM800 display only allows the setup of standard and digital alarm types. You can use SMS to delete an alarm and create a new alarm for evaluating other metered quantities.

### Setpoint-driven Alarms

Many of the alarm conditions require that you define setpoints. This includes all alarms for over, under, and phase unbalance alarm conditions. Other alarm conditions such as digital input transitions and phase reversals do not require setpoints. For those alarm conditions that require setpoints, you must define the following information:

- Pickup Setpoint
- Pickup Delay (in seconds)
- Dropout Setpoint
- Dropout Delay (in seconds)

*NOTE: Alarms with both Pickup and Dropout setpoints set to zero are invalid.*

To understand how the power meter handles setpoint-driven alarms, see Figure 6–2 on page 55. Figure 6–1 shows what the actual alarm Log entries for Figure 6–2 might look like, as displayed by SMS.

*NOTE: The software does not actually display the codes in parentheses—EV1, EV2, Max1, Max2. These are references to the codes in Figure 6–2.*

# Alarms

## About Alarms

Figure 6–1: Sample alarm log entry

PLSD110219

Time	Device	Type	Function	Value	State	Level
03/14/2001 5:16:34.998 PM	CM4000 Office	0	Swell Ib	690	Voltage/Current Swell Dropout	3
03/14/2001 5:16:34.987 PM	CM4000 Office	0	Swell Ia	690	Voltage/Current Swell Dropout	2
03/14/2001 5:16:31.297 PM	CM4000 Office	0	Swell Ia	685	Voltage/Current Swell Pickup	2
03/14/2001 5:16:31.183 PM	CM4000 Office	0	Swell Ia	651	Voltage/Current Swell Dropout	2
03/14/2001 5:16:31.031 PM	CM4000 Office	0	Swell Ia	670	Voltage/Current Swell Pickup	2
03/14/2001 5:16:30.997 PM	CM4000 Office	0	Swell Ib	653	Voltage/Current Swell Pickup	3
03/14/2001 3:39:28.404 PM	CM4000 Office	0	Swell Ib	674	Voltage/Current Swell Dropout	3

Figure 6–2: How the power meter handles setpoint-driven alarms

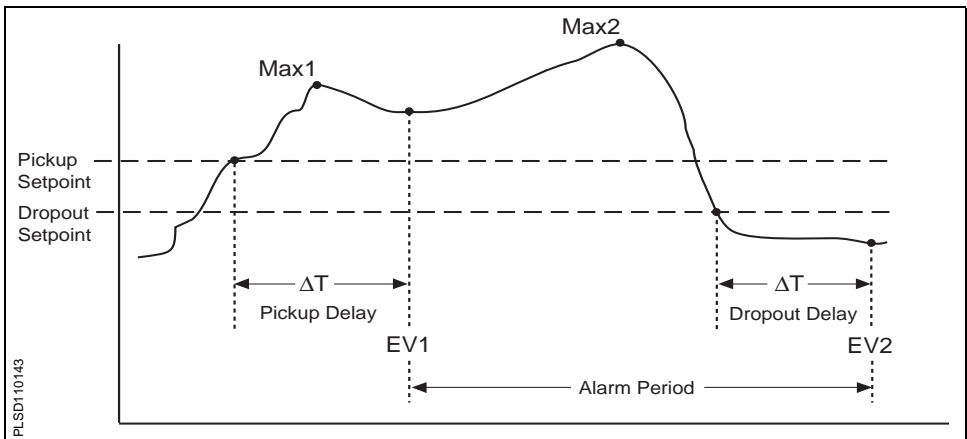

**EV1**—The power meter records the date and time that the pickup setpoint and time delay were satisfied, and the maximum value reached (Max1) during the pickup delay period ( $\Delta T$ ). Also, the power meter performs any tasks assigned to the event such as waveform captures or forced data log entries.

**EV2**—The power meter records the date and time that the dropout setpoint and time delay were satisfied, and the maximum value reached (Max2) during the alarm period.

The power meter also stores a correlation sequence number (CSN) for each event (such as *Under Voltage*

## Alarms

### About Alarms

---

*Phase A Pickup, Under Voltage Phase A Dropout).*

The CSN lets you relate pickups and dropouts in the alarm log. You can sort pickups and dropouts by CSN to correlate the pickups and dropouts of a particular alarm. The pickup and dropout entries of an alarm will have the same CSN. You can also calculate the duration of an event by looking at pickups and dropouts with the same CSN.

### Priorities

Each alarm also has a priority level. Use the priorities to distinguish between events that require immediate action and those that do not require action.

- **High priority**—if a high priority alarm occurs, the display informs you in two ways: the LED backlight on the display flashes until you acknowledge the alarm and the alarm icon blinks while the alarm is active.
- **Medium priority**—if a medium priority alarm occurs, the alarm icon blinks only while the alarm is active. Once the alarm becomes inactive, the alarm icon stops blinking and remains on the display.
- **Low priority**—if a low priority alarm occurs, the alarm icon blinks only while the alarm is active. Once the alarm becomes inactive, the alarm icon disappears from the display.
- **No priority**—if an alarm is setup with no priority, no visible representation will appear on the display. Alarms with no priority are not entered in the Alarm Log. See **Chapter 7—Logging** for alarm logging information.

If multiple alarms with different priorities are active at the same time, the display shows the alarm message for the last alarm that occurred. For instructions on setting up alarms from the power meter display, see “Set Up Alarms” on page 16.



# Alarms

## About Alarms

### Alarm Levels

Using SMS with a PM850, multiple alarms can be set up for one particular quantity (parameter) to create alarm “levels”. You can take different actions depending on the severity of the alarm.

For example, you could set up two alarms for kW Demand. A default alarm already exists for kW Demand, but you could create another custom alarm for kW Demand, selecting different pickup points for it. The custom kW Demand alarm, once created, will appear in the standard alarm list. For illustration purposes, let’s set the default kW Demand alarm to 120 kW and the new custom alarm to 150 kW. One alarm named *kW Demand*; the other *kW Demand 150kW* as shown in Figure 6–3. Note that if you choose to set up two alarms for the same quantity, use slightly different names to distinguish which alarm is active. The display can hold up to 15 characters for each name. You can create up to 10 alarm levels for each quantity.

**Figure 6–3: Two alarms set up for the same quantity with different pickup and dropout set points**

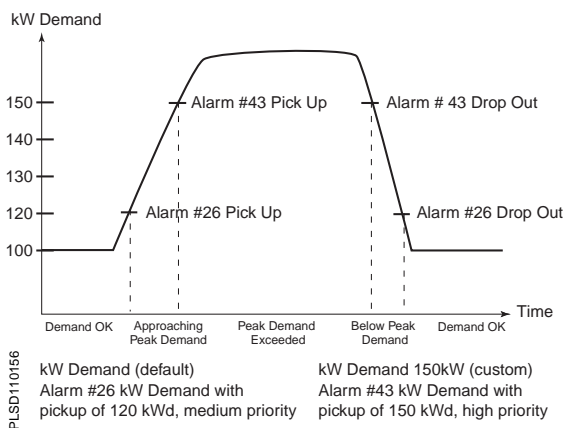

## Alarms

### Custom Alarms

---

#### Custom Alarms

The power meter has many pre-defined alarms, but you can also set up your own custom alarms using SMS. For example, you may need to alarm on the ON-to-OFF transition of a digital input. To create this type of custom alarm:

1. Select the appropriate alarm group (digital in this case).
2. Select the type of alarm (described in Table 6–4 on page 66).
3. Give the alarm a name.

After creating a custom alarm, you can configure it by applying priorities, setting pickups and dropouts (if applicable), and so forth.

#### Types of Setpoint-controlled Functions

This section describes some common motor management functions to which the following information applies:

- Values that are too large to fit into the display may require scale factors. For more information on scale factors, refer to “Changing Scale Factors” on page 168.
- Relays can be configured as normal, latched, or timed. See “Relay Output Operating Modes” on page 45 in **Chapter 5—Input/Output Capabilities** for more information.
- When the alarm occurs, the power meter operates any specified relays. There are two ways to release relays that are in latched mode:
  - Issue a command to de-energize a relay. See **Appendix B—Using the Command Interface** for instructions on using the command interface, or
  - Acknowledge the alarm in the high priority log to release the relays from latched mode. From the main menu of the display, press ALARM to

## Alarms

### Types of Setpoint-controlled Functions

---

view and acknowledge unacknowledged alarms.

The list that follows shows the types of alarms available for some common motor management functions:

*NOTE: Voltage base alarm setpoints depend on your system configuration. Alarm setpoints for 3-wire systems are  $V_{L-L}$  values while 4-wire systems are  $V_{L-N}$  values.*

**Undervoltage:** Pickup and dropout setpoints are entered in volts. The per-phase undervoltage alarm occurs when the per-phase voltage is equal to or below the pickup setpoint long enough to satisfy the specified pickup delay (in seconds). The undervoltage alarm clears when the phase voltage remains above the dropout setpoint for the specified dropout delay period.

**Overvoltage:** Pickup and dropout setpoints are entered in volts. The per-phase overvoltage alarm occurs when the per-phase voltage is equal to or above the pickup setpoint long enough to satisfy the specified pickup delay (in seconds). The overvoltage alarm clears when the phase voltage remains below the dropout setpoint for the specified dropout delay period.

**Unbalance Current:** Pickup and dropout setpoints are entered in tenths of percent, based on the percentage difference between each phase current with respect to the average of all phase currents. For example, enter an unbalance of 7% as 70. The unbalance current alarm occurs when the phase current deviates from the average of the phase currents, by the percentage pickup setpoint, for the specified pickup delay. The alarm clears when the percentage difference between the phase current and the average of all phases remains below the dropout setpoint for the specified dropout delay period.

## Alarms

### Types of Setpoint-controlled Functions

---

**Unbalance Voltage:** Pickup and dropout setpoints are entered in tenths of percent, based on the percentage difference between each phase voltage with respect to the average of all phase voltages. For example, enter an unbalance of 7% as 70. The unbalance voltage alarm occurs when the phase voltage deviates from the average of the phase voltages, by the percentage pickup setpoint, for the specified pickup delay. The alarm clears when the percentage difference between the phase voltage and the average of all phases remains below the dropout setpoint for the specified dropout delay (in seconds).

**Phase Loss—Current:** Pickup and dropout setpoints are entered in amperes. The phase loss current alarm occurs when any current value (but not all current values) is equal to or below the pickup setpoint for the specified pickup delay (in seconds). The alarm clears when one of the following is true:

- All of the phases remain above the dropout setpoint for the specified dropout delay, or
- All of the phases drop below the phase loss pickup setpoint.

If all of the phase currents are equal to or below the pickup setpoint, during the pickup delay, the phase loss alarm will not activate. This is considered an under current condition. It should be handled by configuring the under current protective functions.

**Phase Loss—Voltage:** Pickup and dropout setpoints are entered in volts. The phase loss voltage alarm occurs when any voltage value (but not all voltage values) is equal to or below the pickup setpoint for the specified pickup delay (in seconds). The alarm clears when one of the following is true:

- All of the phases remain above the dropout setpoint for the specified dropout delay (in seconds), OR
- All of the phases drop below the phase loss pickup setpoint.

## Alarms

### Scale Factors

---

If all of the phase voltages are equal to or below the pickup setpoint, during the pickup delay, the phase loss alarm will not activate. This is considered an under voltage condition. It should be handled by configuring the under voltage protective functions.

**Reverse Power:** Pickup and dropout setpoints are entered in kilowatts or kVARs. The reverse power alarm occurs when the power flows in a negative direction and remains at or below the negative pickup value for the specified pickup delay (in seconds). The alarm clears when the power reading remains above the dropout setpoint for the specified dropout delay (in seconds).

**Phase Reversal:** Pickup and dropout setpoints and delays do not apply to phase reversal. The phase reversal alarm occurs when the phase voltage rotation differs from the default phase rotation. The power meter assumes that an ABC phase rotation is normal. If a CBA phase rotation is normal, the user must change the power meter's phase rotation from ABC (default) to CBA. To change the phase rotation from the display, from the main menu select Setup > Meter > Advanced. For more information about changing the phase rotation setting of the power meter, refer to "Advanced Power Meter Setup Options" on page 19.

### Scale Factors

A scale factor is the multiplier expressed as a power of 10. For example, a multiplier of 10 is represented as a scale factor of 1, since  $10^1=10$ ; a multiplier of 100 is represented as a scale factor of 2, since  $10^2=100$ . This allows you to make larger values fit into the register. Normally, you do not need to change scale factors. If you are creating custom alarms, you need to understand how scale factors work so that you do not overflow the register with a number larger than what the register can hold. When SMS is used to set up alarms, it automatically handles the scaling of

## Alarms

### Scale Factors

pickup and dropout setpoints. When creating a custom alarm using the power meter's display, do the following:

- Determine how the corresponding metering value is scaled, and
- Take the scale factor into account when entering alarm pickup and dropout settings.

Pickup and dropout settings must be integer values in the range of -32,767 to +32,767. For example, to set up an under voltage alarm for a 138 kV nominal system, decide upon a setpoint value and then convert it into an integer between -32,767 and +32,767. If the under voltage setpoint were 125,000 V, this would typically be converted to 12500 x 10 and entered as a setpoint of 12500.

Six scale groups are defined (A through F). The scale factor is preset for all factory-configured alarms. Table 6–1 lists the available scale factors for each of the scale groups. If you need either an extended range or more resolution, select any of the available scale factors to suit your need. Refer to “Changing Scale Factors” on page 168 of **Appendix B—Using the Command Interface**.

**Table 6–1: Scale Groups**

Scale Group	Measurement Range	Scale Factor
Scale Group A—Phase Current	Amperes	
	0–327.67 A	–2
	0–3,276.7 A	–1
	0–32,767 A	0 (default)
	0–327.67 kA	1
Scale Group B—Neutral Current	Amperes	
	0–327.67 A	–2
	0–3,276.7 A	–1
	0–32,767 A	0 (default)
	0–327.67 kA	1

# Alarms

## Scaling Alarm Setpoints

**Table 6–1: Scale Groups**

Scale Group	Measurement Range	Scale Factor
Scale Group D—Voltage	Voltage	
	0–3,276.7 V	–1
	0–32,767 V	0 (default)
	0–327.67 kV	1
	0–3,276.7 kV	2
Scale Group F—Power kW, kVAR, kVA	Power	
	0–32.767 kW, kVAR, kVA	–3
	0–327.67 kW, kVAR, kVA	–2
	0–3,276.7 kW, kVAR, kVA	–1
	0–32,767 kW, kVAR, kVA	0 (default)
	0–327.67 MW, MVAR, MVA	1
	0–3,276.7 MW, MVAR, MVA	2
	0–32,767 MW, MVAR, MVA	3

### Scaling Alarm Setpoints

This section is for users who do not have SMS and must set up alarms from the power meter display. It explains how to scale alarm setpoints.

When the power meter is equipped with a display, most metered quantities are limited to five characters (plus a positive or negative sign). The display will also show the engineering units applied to that quantity.

To determine the proper scaling of an alarm setpoint, view the register number for the associated scale group. The scale factor is the number in the Dec column for that register. For example, the register number for Scale D to Phase Volts is 3212. If the number in the Dec column is 1, the scale factor is  $10^1=10$ . Remember that scale factor 1 in Table 6–2 on page 64 for Scale Group D is measured in kV. Therefore, to define an alarm setpoint of 125 kV, enter 12.5 because 12.5 multiplied by 10 is 125. Below is a table listing the scale groups and their register numbers.

## Alarms

### Alarm Conditions and Alarm Numbers

**Table 6–2: Scale Group Register Numbers**

Scale Group	Register Number
Scale Group A—Phase Current	3209
Scale Group B—Neutral Current	3210
Scale Group C—Ground Current	3211
Scale Group D—Voltage	3212
Scale Group F—Power kW, kVAR, kVA	3214

### Alarm Conditions and Alarm Numbers

This section lists the power meter's predefined alarm conditions. For each alarm condition, the following information is provided.

- **Alarm No.**—a position number indicating where an alarm falls in the list.
- **Alarm Description**—a brief description of the alarm condition
- **Abbreviated Display Name**—an abbreviated name that describes the alarm condition, but is limited to 15 characters that fit in the window of the power meter's display.
- **Test Register**—the register number that contains the value (where applicable) that is used as the basis for a comparison to alarm pickup and dropout settings.
- **Units**—the unit that applies to the pickup and dropout settings.
- **Scale Group**—the scale group that applies to the test register's metering value (A–F). For a description of scale groups, see “Scale Factors” on page 61.
- **Alarm Type**—a reference to a definition that provides details on the operation and configuration of the alarm. For a description of alarm types, refer to Table 6–4 on page 66.

Table 6–3 on page 65 lists the preconfigured alarms by alarm number.



# Alarms

## Alarm Conditions and Alarm Numbers

Table 6-3: List of Default Alarms by Alarm Number

Alarm Number	Alarm Description	Abbreviated Display Name	Test Register	Units	Scale Group	Alarm Type ①
<b>Standard Speed Alarms (1 Second)</b>						
01	Over Current Phase A	Over Ia	1100	Amperes	A	010
02	Over Current Phase B	Over Ib	1101	Amperes	A	010
03	Over Current Phase C	Over Ic	1102	Amperes	A	010
04	Over Current Neutral	Over In	1103	Amperes	B	010
05	Current Unbalance, Max	I Unbal Max	1110	Tenths %	—	010
06	Current Loss	Current Loss	3262	Amperes	A	053
07	Over Voltage Phase A-N	Over Van	1124	Volts	D	010
08	Over Voltage Phase B-N	Over Vbn	1125	Volts	D	010
09	Over Voltage Phase C-N	Over Vcn	1126	Volts	D	010
10	Over Voltage Phase A-B	Over Vab	1120	Volts	D	010
11	Over Voltage Phase B-C	Over Vbc	1121	Volts	D	010
12	Over Voltage Phase C-A	Over Vca	1122	Volts	D	010
13	Under Voltage Phase A	Under Van	1124	Volts	D	020
14	Under Voltage Phase B	Under Vbn	1125	Volts	D	020
15	Under Voltage Phase C	Under Vcn	1126	Volts	D	020
16	Under Voltage Phase A-B	Under Vab	1120	Volts	D	020
17	Under Voltage Phase B-C	Under Vbc	1121	Volts	D	020
18	Under Voltage Phase C-A	Under Vca	1122	Volts	D	020
19	Voltage Unbalance L-N, Max	V Unbal L-N Max	1136	Tenths %	—	010
20	Voltage Unbalance L-L, Max	V Unbal L-L Max	1132	Tenths %	—	010
21	Voltage Loss (loss of A,B,C, but not all)	Voltage Loss	3262	Volts	D	052
22	Phase Reversal	Phase Rev	3228	—	—	051
23	Over kW Demand	Over kW Dmd	2151	kW	F	011
24	Lagging true power factor	Lag True PF	1163	Thousandths	—	055
25-40	Reserved for custom alarms.	—	—	—	—	—
<b>Digital</b>						
01	End of incremental energy interval	End Inc Enr Int	N/A	—	—	070
02	End of power demand interval	End Dmd Int	N/A	—	—	070
03	Power up/Reset	Pwr Up/Reset	N/A	—	—	070
04	Digital Input OFF/ON	DIG IN S02	2	—	—	060
05-40	Reserved for custom alarms	—	—	—	—	—

① Alarm Types are described in Table 6-4 on page 66.

# Alarms

## Alarm Conditions and Alarm Numbers



Table 6-4: Alarm Types

Type	Description	Operation
<b>Standard Speed</b>		
010	Over Value Alarm	If the test register value exceeds the setpoint long enough to satisfy the pickup delay period, the alarm condition will be true. When the value in the test register falls below the dropout setpoint long enough to satisfy the dropout delay period, the alarm will dropout. Pickup and dropout setpoints are positive, delays are in seconds.
011	Over Power Alarm	If the absolute value in the test register exceeds the setpoint long enough to satisfy the pickup delay period, the alarm condition will be true. When absolute the value in the test register falls below the dropout setpoint long enough to satisfy the dropout delay period, the alarm will dropout. Pickup and dropout setpoints are positive, delays are in seconds.
012	Over Reverse Power Alarm	If the absolute value in the test register exceeds the setpoint long enough to satisfy the pickup delay period, the alarm condition will be true. When absolute the value in the test register falls below the dropout setpoint long enough to satisfy the dropout delay period, the alarm will dropout. This alarm will only hold true for reverse power conditions. Positive power values will not cause the alarm to occur. Pickup and dropout setpoints are positive, delays are in seconds.
020	Under Value Alarm	If the test register value is below the setpoint long enough to satisfy the pickup delay period, the alarm condition will be true. When the value in the test register rises above the dropout setpoint long enough to satisfy the dropout delay period, the alarm will dropout. Pickup and dropout setpoints are positive, delays are in seconds.
021	Under Power Alarm	If the absolute value in the test register is below the setpoint long enough to satisfy the pickup delay period, the alarm condition will be true. When the absolute value in the test register rises above the dropout setpoint long enough to satisfy the dropout delay period, the alarm will dropout. Pickup and dropout setpoints are positive, delays are in seconds.
051	Phase Reversal	The phase reversal alarm will occur whenever the phase voltage waveform rotation differs from the default phase rotation. The ABC phase rotation is assumed to be normal. If a CBA phase rotation is normal, the user should reprogram the power meter's phase rotation ABC to CBA phase rotation. The pickup and dropout setpoints and delays for phase reversal do not apply.
052	Phase Loss, Voltage	The phase loss voltage alarm will occur when any one or two phase voltages (but not all) fall to the pickup value and remain at or below the pickup value long enough to satisfy the specified pickup delay. When all of the phases remain at or above the dropout value for the dropout delay period, or when all of the phases drop below the specified phase loss pickup value, the alarm will dropout. Pickup and dropout setpoints are positive, delays are in seconds.
053	Phase Loss, Current	The phase loss current alarm will occur when any one or two phase currents (but not all) fall to the pickup value and remain at or below the pickup value long enough to satisfy the specified pickup delay. When all of the phases remain at or above the dropout value for the dropout delay period, or when all of the phases drop below the specified phase loss pickup value, the alarm will dropout. Pickup and dropout setpoints are positive, delays are in seconds.

# Alarms

## Alarm Conditions and Alarm Numbers

Table 6-4: Alarm Types

Type	Description	Operation
054	Leading Power Factor	The leading power factor alarm will occur when the test register value becomes more leading than the pickup setpoint (such as closer to 0.010) and remains more leading long enough to satisfy the pickup delay period. When the value becomes equal to or less leading than the dropout setpoint, that is 1.000, and remains less leading for the dropout delay period, the alarm will dropout. Both the pickup setpoint and the dropout setpoint must be positive values representing leading power factor. Enter setpoints as integer values representing power factor in thousandths. For example, to define a dropout setpoint of 0.5, enter 500. Delays are in seconds.
055	Lagging Power Factor	The lagging power factor alarm will occur when the test register value becomes more lagging than the pickup setpoint (such as closer to -0.010) and remains more lagging long enough to satisfy the pickup delay period. When the value becomes equal to or less lagging than the dropout setpoint and remains less lagging for the dropout delay period, the alarm will dropout. Both the pickup setpoint and the dropout setpoint must be positive values representing lagging power factor. Enter setpoints as integer values representing power factor in thousandths. For example, to define a dropout setpoint of -0.5, enter 500. Delays are in seconds.
<b>Digital</b>		
060	Digital Input On	The digital input transition alarms will occur whenever the digital input changes from off to on. The alarm will dropout when the digital input changes back to off from on. The pickup and dropout setpoints and delays do not apply.
061	Digital Input Off	The digital input transition alarms will occur whenever the digital input changes from on to off. The alarm will dropout when the digital input changes back to on from off. The pickup and dropout setpoints and delays do not apply.
070	Unary	This is a internal signal from the power meter and can be used, for example, to alarm at the end of an interval or when the power meter is reset. Neither the pickup and dropout delays nor the setpoints apply.
<b>Boolean</b>		
100	Logic AND 	The AND alarm will occur when <i>all</i> of the combined enabled alarms are true (up to 4). The alarm will dropout when <i>any</i> of the enabled alarms drops out.
101	Logic NAND 	The NAND alarm will occur when <i>any, but not all, or none</i> of the combined enabled alarms are true. The alarm will dropout when <i>all</i> of the enabled alarms drop out, or <i>all are true</i> .
102	Logic OR 	The OR alarm will occur when <i>any</i> of the combined enabled alarms are true (up to 4). The alarm will dropout when <i>all</i> of the enabled alarms are <i>false</i> .

## Alarms

### Alarm Conditions and Alarm Numbers

Table 6-4: Alarm Types

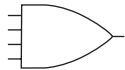
Type	Description	Operation
103	Logic NOR 	The NOR alarm will occur when <i>none</i> of the combined enabled alarms are true (up to 4). The alarm will dropout when <i>any</i> of the enabled alarms are <i>true</i> .
104	Logic XOR 	The XOR alarm will occur when <i>only one</i> of the combined enabled alarms is true (up to 4). The alarm will dropout when <i>the enabled alarm drops out</i> or when more than one alarm becomes <i>true</i> .

# Logging

## Introduction

### Introduction

This chapter briefly describes the following logs of the power meter:

- Alarm log
- User-defined data logs
- Billing log
- Maintenance log

Logs are files stored in the nonvolatile memory of power meter and are referred to as “onboard logs.” Use SMS to set up and view all the logs. See the SMS online help for information about working with the power meter’s onboard logs. Waveform captures are stored in the power meter’s memory, but they are not considered logs (see **Chapter 8—Waveform Capture** on page 77). Refer to “Memory Allocation for Log Files” for information about shared memory in the power meter.

### Memory Allocation for Log Files

Each file in the power meter has a maximum memory size. Memory is not shared between the different logs, so reducing the number of values recorded in a one log will not allow more values to be stored in a different log. The following table lists the memory allocated to each log:

**Table 7–1: Memory Allocation for Each Log**

Log Type	Max. Records Stored	Max. Register Values Recorded	Storage (Bytes)
Data Log 1	5000	96 + 3 D/T	14,808
Data Log 2	5000	96 + 3 D/T	393,216
Data Log 3	5000	96 + 3 D/T	393,216
Alarm Log	100	11	2,200
Maintenance Log	40	4	320
Billing Log	5000	96 + 3 D/T	65,536

## Logging

### Alarm Log

---

#### Alarm Log

By default, the power meter can log the occurrence of any alarm condition. Each time an alarm occurs it is entered into the alarm log. The alarm log in the power meter stores the pickup and dropout points of alarms along with the date and time associated with these alarms. You select whether the alarm log saves data as first-in-first-out (FIFO) or fill and hold. With SMS, you can view and save the alarm log to disk, and reset the alarm log to clear the data out of the power meter's memory.

#### Alarm Log Storage

The power meter stores alarm log data in nonvolatile memory. The size of the alarm log is fixed at 100 records.

#### Data Logs

The power meter records meter readings at regularly scheduled intervals and stores the data in up to three independent data logs. Some data log files are preconfigured at the factory. You can accept the preconfigured data logs or change them to meet your specific needs. You can set up each data log to store the following information:

- **Timed Interval**—1 second to 24 hours for Data Log 1, and 1 minute to 24 hours for Data Logs 2 and 3 (how often the values are logged)
- **First-In-First-Out (FIFO) or Fill and Hold**
- **Values to be logged**—up to 96 registers along with the date and time of each log entry
- **START/STOP Time**—each log has the ability to start and stop at a certain time during the day

Use SMS to clear each data log file, independently of the others, from the power meter's memory. For

## Logging

### Data Logs

---

instructions on setting up and clearing data log files, refer to the SMS online help file.

#### Alarm-driven Data Log Entries

The power meter can detect over 50 alarm conditions, including over/under conditions, digital input changes, phase unbalance conditions, and more. (See **Chapter 6—Alarms** on page 53 for more information.) Use SMS to assign each alarm condition one or more tasks, including forcing data log entries into one or more data log files.

For example, assume that you've defined 3 data log files. Using SMS, you could select an alarm condition such as "Overcurrent Phase A" and set up the power meter to force data log entries into any of the 3 log files each time the alarm condition occurs.

#### Organizing Data Log Files

You can organize data log files in many ways. One possible way is to organize log files according to the logging interval. You might also define a log file for entries forced by alarm conditions. For example, you could set up three data log files as follows:

## Logging

### Billing Log

<b>Data Log 1:</b>	Log voltage every minute. Make the file large enough to hold 60 entries so that you could look back over the last hour's voltage readings.
<b>Data Log 2:</b>	Log energy once every day. Make the file large enough to hold 31 entries so that you could look back over the last month and see daily energy use.
<b>Data Log 3:</b>	Report by exception. The report by exception file contains data log entries that are forced by the occurrence of an alarm condition. See the previous section "Alarm-driven Data Log Entries" for more information.

*NOTE: The same data log file can support both scheduled and alarm-driven entries.*

### Billing Log

The power meter stores a configurable billing log that is updated every 15 minutes. Data is stored by month, day, and 15 minute intervals. The log contains 24 months of monthly data and 32 days of daily data, but because the maximum amount of memory for the billing log is 64KB, the number of recorded 15 minute intervals varies based on the number of registers recorded in the billing log. For example, using all of the registers listed in Table 7–2, the billing log holds 12 days of data at 15 minute intervals. This value is calculated by doing the following:

1. Calculate the total number of registers used (see Table 7–2 for the number of registers). In this example, all 26 registers are used.
2. Calculate the number of bytes used for the 24 monthly records.

$$24 \text{ records} (26 \text{ registers} \times 2 \text{ bytes/register}) = 1,248$$



## Logging

### Maintenance Log

- Calculate the number of bytes used for the 32 daily records.  
 $32 (26 \times 2) = 1,664$
- Calculate the number of bytes used each day.  
 $96 (26 \times 2) = 4,992$
- Calculate the number of days of 15 minute interval data recorded by subtracting the values from steps 2 and 3 from the total log file size of 65,536 bytes and then dividing by the value in step 4.  
 $(65,536 - 1,248 - 1,664) \div 4,992 = 12 \text{ days}$

**Table 7–2: Billing Log Register List**

Description	Number of Registers	Data Type <sup>①</sup>	Register Number
Start Date/Time	3	D/T	Current D/T
Real Energy In	4	MOD10L4	1700
Reactive Energy In	4	MOD10L4	1704
Real Energy Out	4	MOD10L4	1708
Reactive Energy Out	4	MOD10L4	1712
Apparent Energy Total	4	MOD10L4	1724
Total PF	1	INT16	1163
3P Real Power Demand	1	INT16	2151
3P Apparent Power Demand	1	INT16	2181

<sup>①</sup> Refer to Appendix A for more information about data types.

## Maintenance Log

The power meter stores a maintenance log in nonvolatile memory. The file has a fixed record length of four registers and a total of 40 records. The first register is a cumulative counter over the life of the Power Meter. The last three registers contain the date/time of when the log was updated. Table 7–3 describes the values stored in the maintenance log.

## Logging

### Maintenance Log

These values are cumulative over the life of the power meter and cannot be reset.

*NOTE: Use SMS to view the maintenance log. Refer to the SMS online help for instructions.*

**Table 7-3: Values Stored in the Maintenance Log**

Record Number	Value Stored
1	Time stamp of the last change
2	Date and time of the last power failure
3	Date and time of the last firmware download
4	Date and time of the last option module change
5	Date and time of the latest LVC update due to configuration errors detected during meter initialization
6-11	Reserved
12	Date and time the Present Month Min/Max was last reset
13	Date and time the Previous Month Min/Max was last reset
14	Date and time the Energy Pulse Output was overdriven
15	Date and time the Power Demand Min/Max was last reset
16	Date and time the Current Demand Min/Max was last reset
17	Date and time the Generic Demand Min/Max was last reset
18	Date and time the Input Demand Min/Max was last reset
19	Reserved
20	Date and time the Accumulated Energy value was last reset
21	Date and time the Conditional Energy value was last reset
22	Date and time the Incremental Energy value was last reset
23	Reserved
24	Date and time of the last Standard KY Output operation
25	Date and time of the last Discrete Output @A01 operation <sup>①</sup>
26	Date and time of the last Discrete Output @A02 operation <sup>①</sup>

# Logging

## Maintenance Log

**Table 7-3: Values Stored in the Maintenance Log**

27	Date and time of the last Discrete Output @A03 operation <sup>①</sup>
28	Date and time of the last Discrete Output @A04 operation <sup>①</sup>
29	Date and time of the last Discrete Output @A05 operation <sup>①</sup>
30	Date and time of the last Discrete Output @A06 operation <sup>①</sup>
31	Date and time of the last Discrete Output @A07 operation <sup>①</sup>
32	Date and time of the last Discrete Output @A08 operation <sup>①</sup>
33	Date and time of the last Discrete Output @B01 operation <sup>①</sup>
34	Date and time of the last Discrete Output @B02 operation <sup>①</sup>
35	Date and time of the last Discrete Output @B03 operation <sup>①</sup>
36	Date and time of the last Discrete Output @B04 operation <sup>①</sup>
37	Date and time of the last Discrete Output @B05 operation <sup>①</sup>
38	Date and time of the last Discrete Output @B06 operation <sup>①</sup>
39	Date and time of the last Discrete Output @B07 operation <sup>①</sup>
40	Date and time of the last Discrete Output @B08 operation <sup>①</sup>

<sup>①</sup> Additional outputs require option modules and are based on the I/O configuration of that particular module.

## Logging Maintenance Log

---

# Waveform Capture

## Waveform Capture

---

### Waveform Capture

The waveform capture can be initiated manually to analyze steady-state harmonics. This waveform provides information about individual harmonics, which SMS calculates through the 63rd harmonic. It also calculates total harmonic distortion (THD) and other power quality parameters. The waveform capture records a maximum of five individual three cycle captures at 128 samples per cycle simultaneously on all metered channels.

### Initiating a Waveform

Using SMS from a remote PC, initiate a waveform capture manually by selecting the power meter and issuing the acquire command. SMS will automatically retrieve the waveform capture from the power meter. You can display the waveform for all three phases, or zoom in on a single waveform, which includes a data block with extensive harmonic data. See the SMS online help for instructions.

### Waveform Storage

The power meter can store multiple captured waveforms in its nonvolatile memory. The number of waveforms that can be stored is based on the number selected. The maximum number of stored waveforms is five. All stored waveform data is retained on power-loss.

### Waveform Storage Modes

There are two ways to store waveform captures: "FIFO" and "Fill and Hold." FIFO mode allows the file to fill up the waveform capture file. After the file is full, the oldest waveform capture is removed, and the most recent waveform capture is added to the file. The Fill and Hold mode fills the file until the

## Waveform Capture

### Waveform Storage

---

configured number of waveform captures is reached. New waveform captures cannot be added until the file is cleared.

# Maintenance and Troubleshooting

## Introduction

---

### Introduction

This chapter describes information related to maintenance of your power meter.

The power meter does not contain any user-serviceable parts. If the power meter requires service, contact your local sales representative. Do not open the power meter. Opening the power meter voids the warranty.

### CAUTION

#### HAZARD OF EQUIPMENT DAMAGE

Do not perform a Dielectric (Hi-Pot) or Megger test on the power meter. High voltage testing of the power meter may damage the unit. Before performing Hi-Pot or Megger testing on any equipment in which the power meter is installed, disconnect all input and output wires to the power meter.

**Failure to follow this instruction can result in injury or equipment damage.**

### Power Meter Memory

The power meter uses its nonvolatile memory (RAM) to retain all data and metering configuration values. Under the operating temperature range specified for the power meter, this nonvolatile memory has an expected life of up to 100 years. The power meter stores its data logs on a memory chip, which has a life expectancy of up to 20 years under the operating temperature range specified for the power meter. The life of the power meter's internal battery-backed clock is over 10 years at 25°C.

*NOTE: Life expectancy is a function of operating conditions; this does not constitute any expressed or implied warranty.*

## Maintenance and Troubleshooting

Identifying the Firmware Version, Model, and

### Identifying the Firmware Version, Model, and Serial Number

1. From the first menu level, press **→** until DIAGN (diagnostics) is visible.
2. Enter your password, then press OK.
3. Press METER.
4. View the model, firmware (OS) version, and serial number.
5. Press **↑** to return to the DIAGNOSTICS screen.

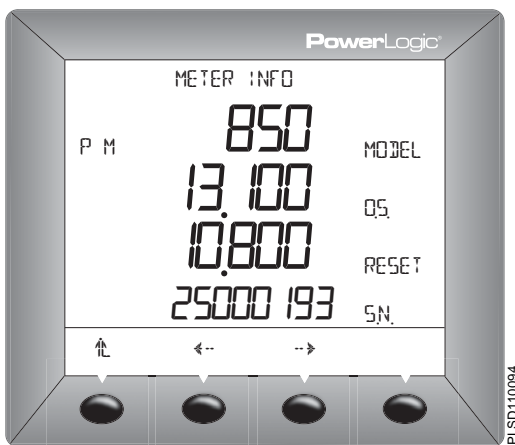

### Viewing the Display in Different Languages

The power meter can be set to use one of three different languages: English, French, and Spanish. Other languages are available. Please contact your local sales representative for more information about other language options.

The power meter language can be selected by doing the following:



## Maintenance and Troubleshooting

### Getting Technical Support

1. From the first menu level, press  $\rightarrow$  until SETUP is visible.
2. Enter your password, then press OK.
3. Press  $\rightarrow$  until LANG is visible.
4. Press LANG.
5. Select the language: ENGL, SPAN, or FREN.
6. Press  $\uparrow$  to return to the METER SETUP screen.



### Getting Technical Support

Please refer to the *Technical Support Contacts* provided in the power meter shipping carton for a list of support phone numbers by country.

# Maintenance and Troubleshooting

## Troubleshooting

### Troubleshooting

The information in Table 9–1 describes potential problems and their possible causes. It also describes checks you can perform or possible solutions for each. After referring to this table, if you cannot resolve the problem, contact the your local Square D/Schneider Electric sales representative for assistance.

#### **DANGER**

##### **HAZARD OF ELECTRIC SHOCK, BURN, OR EXPLOSION**

- This equipment must be installed and serviced only by qualified personnel.
- Turn off all power supplying this equipment before working on or inside.
- Always use a properly rated voltage sensing device to confirm that all power is off.
- Qualified persons performing diagnostics or troubleshooting that require electrical conductors to be energized must comply with NFPA 70 E - Standard for Electrical Safety Requirements for Employee Workplaces and OSHA Standards - 29 CFR Part 1910 Subpart S - Electrical.
- Carefully inspect the work area for tools and objects that may have been left inside the equipment.
- Use caution while removing or installing panels so that they do not extend into the energized bus; avoid handling the panels, which could cause personal injury.

**Failure to follow this instruction will result in death or serious injury.**

# Maintenance and Troubleshooting

## Troubleshooting

**Table 9–1: Troubleshooting**

Potential Problem	Possible Cause	Possible Solution
The maintenance icon is illuminated on the power meter display.	When the maintenance icon is illuminated, it indicates a potential hardware or firmware problem in the power meter.	When the maintenance icon is illuminated, go to <b>DIAGNOSTICS &gt; MAINTENANCE</b> . Error messages display to indicate the reason the icon is illuminated. Note these error messages and call Technical Support or contact your local sales representative for assistance.
The display is blank after applying control power to the power meter.	The power meter may not be receiving the necessary power.	<ul style="list-style-type: none"> <li>• Verify that the power meter line (L) and neutral (N) terminals (terminals 25 and 27) are receiving the necessary power.</li> <li>• Verify that the heartbeat LED is blinking.</li> <li>• Check the PLSD110074.</li> </ul>
The data being displayed is inaccurate or not what you expect.	Power meter is grounded incorrectly.	Verify that the power meter is grounded as described in "Grounding the Power Meter" in the installation manual.
	Incorrect setup values.	Check that the correct values have been entered for power meter setup parameters (CT and PT ratings, System Type, Nominal Frequency, and so on). See "Set Up the Power Meter" on page 12 for setup instructions.
	Incorrect voltage inputs.	Check power meter voltage input terminals L (8, 9, 10, 11) to verify that adequate voltage is present.
	Power meter is wired improperly.	Check that all CTs and PTs are connected correctly (proper polarity is observed) and that they are energized. Check shorting terminals. See <b>Chapter 4 — Wiring</b> in the installation manual. Initiate a wiring check from the power meter display.

## Maintenance and Troubleshooting

### Troubleshooting

**Table 9-1: Troubleshooting**

Cannot communicate with power meter from a remote personal computer.	Power meter address is incorrect.	Check to see that the power meter is correctly addressed. See "Set Up Communications" on page 12 for instructions.
	Power meter baud rate is incorrect.	Verify that the baud rate of the power meter matches the baud rate of all other devices on its communications link. See "Set Up Communications" on page 12 for instructions.
	Communications lines are improperly connected.	Verify the power meter communications connections. Refer to <b>Chapter 5 — Communications</b> in the installation manual for instructions.
	Communications lines are improperly terminated.	Check to see that a multipoint communications terminator is properly installed. See "Terminating the Communications Link" on page 28 in the installation manual for instructions.
	Incorrect route statement to power meter.	Check the route statement. Refer to the SMS online help for instructions on defining route statements.

# Power Meter Register List

## About Registers

### About Registers

The four tables in this appendix contain an abbreviated listing of power meter registers. For registers defined in bits, the rightmost bit is referred to as bit 00. Figure A–1 shows how bits are organized in a register.

**Figure A–1: Bits in a register**

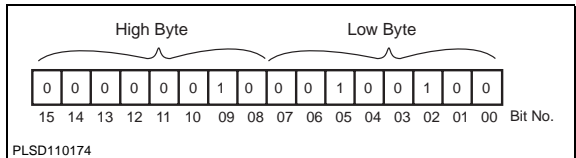

The power meter registers can be used with MODBUS or JBUS protocols. Although the MODBUS protocol uses a zero-based register addressing convention and JBUS protocol uses a one-based register addressing convention, the power meter automatically compensates for the MODBUS offset of one. Regard all registers as holding registers where a 30,000 or 40,000 offset can be used. For example, Current Phase A will reside in register 31,100 or 41,100 instead of 1,100 as listed in Table A–3 on page 87.

### How Power Factor is Stored in the Register

Each power factor value occupies one register. Power factor values are stored using signed magnitude notation (see Figure A–2 below). Bit number 15, the sign bit, indicates leading/lagging. A positive value (bit 15=0) always indicates leading. A negative value (bit 15=1) always indicates lagging. Bits 0–9 store a value in the range 0–1,000 decimal. For example the power meter would return a leading power factor of 0.5 as 500. Divide by 1,000 to get a power factor in the range 0 to 1.000.

## Power Meter Register List

How Date and Time are Stored in Registers

**Figure A-2: Power factor PLSD110176**

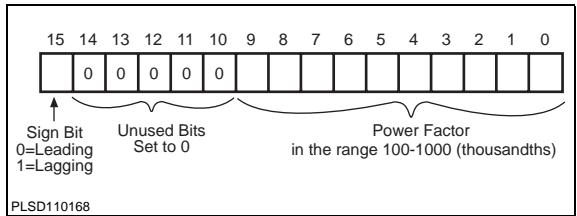

When the power factor is lagging, the power meter returns a high negative value—for example, -31,794. This happens because bit 15=1 (for example, the binary equivalent of -31,794 is 1000001111001110). To get a value in the range 0 to 1,000, you need to mask bit 15. You do this by adding 32,768 to the value. An example will help clarify.

Assume that you read a power factor value of -31,794. Convert this to a power factor in the range 0 to 1.000, as follows:

$$-31,794 + 32,768 = 974$$

$$974/1,000 = .974 \text{ lagging power factor}$$

## How Date and Time are Stored in Registers

The date and time are stored in a three-register compressed format. Each of the three registers, such as registers 1810 to 1812, contain a high and low byte value to represent the date and time in hexadecimal. Table A-1 lists the register and the portion of the date or time it represents.

**Table A-1: Date and Time Format**

Register	Hi Byte	Lo Byte
Register 0	Month (1-12)	Day (1-31)
Register 1	Year (0-199)	Hour (0-23)
Register 2	Minute (0-59)	Second (0-59)

# Power Meter Register List

## Register List

For example, if the date was 01/25/00 at 11:06:59, the Hex value would be 0119, 640B, 063B. Breaking it down into bytes we have the following:

*NOTE: Date format is a 3 (6-byte) register compressed format. (Year 2001 is represented as 101 in the year byte.)*

**Table A-2: Date and Time Byte Example**

Hexadecimal Value	Hi Byte	Lo Byte
0119	01 = month	19 = day
640B	64 = year	0B = hour
063B	06 = minute	3B = seconds

## Register List

**Table A-3: Abbreviated Register List**

Reg	Name	Scale	Units	Range	Notes
<b>1s Metering</b>					
<b>1s Metering — Current</b>					
1100	Current, Phase A	A	Amps/Scale	0 – 32,767	RMS
1101	Current, Phase B	A	Amps/Scale	0 – 32,767	RMS
1102	Current, Phase C	A	Amps/Scale	0 – 32,767	RMS
1103	Current, Neutral	B	Amps/Scale	0 – 32,767 (-32,768 if N/A)	RMS (4-wire system only)
1105	Current, 3-Phase Average	A	Amps/Scale	0 – 32,767	Calculated mean of Phases A, B & C
1107	Current, Unbalance, Phase A	—	0.10%	0 – 1,000	
1108	Current, Unbalance, Phase B	—	0.10%	0 – 1,000	
1109	Current, Unbalance, Phase C	—	0.10%	0 – 1,000	
1110	Current, Unbalance, Max	—	0.10%	0 – 1,000	Percent Unbalance, Worst
<b>1s Metering — Voltage</b>					
1120	Voltage, A-B	D	Volts/Scale	0 – 32,767	Fundamental RMS Voltage measured between A & B

# Power Meter Register List

## Register List

**Table A-3: Abbreviated Register List**

Reg	Name	Scale	Units	Range	Notes
1121	Voltage, B-C	D	Volts/Scale	0 – 32,767	Fundamental RMS Voltage measured between B & C
1122	Voltage, C-A	D	Volts/Scale	0 – 32,767	Fundamental RMS Voltage measured between C & A
1123	Voltage, L-L Average	D	Volts/Scale	0 – 32,767	Fundamental RMS 3 Phase Average L-L Voltage
1124	Voltage, A-N	D	Volts/Scale	0 – 32,767 (-32,768 if N/A)	Fundamental RMS Voltage measured between A & N 4-wire system only
1125	Voltage, B-N	D	Volts/Scale	0 – 32,767 (-32,768 if N/A)	Fundamental RMS Voltage measured between B & N 4-wire system only
1126	Voltage, C-N	D	Volts/Scale	0 – 32,767 (-32,768 if N/A)	Fundamental RMS Voltage measured between C & N 4-wire system only
1127	Voltage, N-R	E	Volts/Scale	0 – 32,767 (-32,768 if N/A)	Fundamental RMS Voltage measured between N & Meter Reference 4-wire system with 4 element metering only
1128	Voltage, L-N Average	D	Volts/Scale	0 – 32,767	Fundamental RMS 3-Phase Average L-N Voltage
1129	Voltage, Unbalance, A-B	—	0.10%	0 – 1,000	Percent Voltage Unbalance, Phase A-B
1130	Voltage, Unbalance, B-C	—	0.10%	0 – 1,000	Percent Voltage Unbalance, Phase B-C
1131	Voltage, Unbalance, C-A	—	0.10%	0 – 1,000	Percent Voltage Unbalance, Phase C-A
1132	Voltage, Unbalance, Max L-L	—	0.10%	0 – 1,000	Percent Voltage Unbalance, Worst L-L
1133	Voltage, Unbalance, A-N	—	0.10%	0 – 1,000 (-32,768 if N/A)	Percent Voltage Unbalance, Phase A-N 4-wire system only
1134	Voltage, Unbalance, B-N	—	0.10%	0 – 1,000 (-32,768 if N/A)	Percent Voltage Unbalance, Phase B-N 4-wire system only
1135	Voltage, Unbalance, C-N	—	0.10%	0 – 1,000 (-32,768 if N/A)	Percent Voltage Unbalance, Phase C-N 4-wire system only
1136	Voltage, Unbalance, Max L-N	—	0.10%	0 – 1,000 (-32,768 if N/A)	Percent Voltage Unbalance, Worst L-N 4-wire system only
<b>1s Metering — Power</b>					
1140	Real Power, Phase A	F	kW/Scale	-32,767 – 32,767 (-32,768 if N/A)	Real Power (PA) 4-wire system only



# Power Meter Register List

## Register List

**Table A-3: Abbreviated Register List**

Reg	Name	Scale	Units	Range	Notes
1141	Real Power, Phase B	F	kW/Scale	-32,767 – 32,767 (-32,768 if N/A)	Real Power (PB) 4-wire system only
1142	Real Power, Phase C	F	kW/Scale	-32,767 – 32,767 (-32,768 if N/A)	Real Power (PC) 4-wire system only
1143	Real Power, Total	F	kW/Scale	-32,767 – 32,767	4-wire system = PA+PB+PC 3-wire system = 3-Phase real power
1144	Reactive Power, Phase A	F	kVAr/Scale	-32,767 – 32,767 (-32,768 if N/A)	Reactive Power (QA) 4-wire system only
1145	Reactive Power, Phase B	F	kVAr/Scale	-32,767 – 32,767 (-32,768 if N/A)	Reactive Power (QB) 4-wire system only
1146	Reactive Power, Phase C	F	kVAr/Scale	-32,767 – 32,767 (-32,768 if N/A)	Reactive Power (QC) 4-wire system only
1147	Reactive Power, Total	F	kVAr/Scale	-32,767 – 32,767	4-wire system = QA+QB+QC 3 wire system = 3-Phase reactive power
1148	Apparent Power, Phase A	F	kVA/Scale	-32,767 – 32,767 (-32,768 if N/A)	Apparent Power (SA) 4-wire system only
1149	Apparent Power, Phase B	F	kVA/Scale	-32,767 – 32,767 (-32,768 if N/A)	Apparent Power (SB) 4-wire system only
1150	Apparent Power, Phase C	F	kVA/Scale	-32,767 – 32,767 (-32,768 if N/A)	Apparent Power (SC) 4-wire system only
1151	Apparent Power, Total	F	kVA/Scale	-32,767 – 32,767	4-wire system = SA+SB+SC 3-wire system = 3-Phase apparent power
<b>1s Metering — Power Factor</b>					
1160	True Power Factor, Phase A	—	0.001	1,000 -200 to 200 (-32,768 if N/A)	Derived using the complete harmonic content of real and apparent power. 4-wire system only
1161	True Power Factor, Phase B	—	0.001	1,000 -200 to 200 (-32,768 if N/A)	Derived using the complete harmonic content of real and apparent power. 4-wire system only

# Power Meter Register List

## Register List

**Table A-3: Abbreviated Register List**

Reg	Name	Scale	Units	Range	Notes
1162	True Power Factor, Phase C	—	0.001	1,000 -200 to 200 (-32,768 if N/A)	Derived using the complete harmonic content of real and apparent power. 4-wire system only
1163	True Power Factor, Total	—	0.001	1,000 -200 to 200 (-32,768 if N/A)	Derived using the complete harmonic content of real and apparent power
1164	Alternate True Power Factor, Phase A	—	0.001	1,000 -200 to 200 (-32,768 if N/A)	Derived using the complete harmonic content of real and apparent power (4-wire system only). Reported value is mapped from 0-2000, with 1000 representing unity, values below 1000 representing lagging, and values above 1000 representing leading.
1165	Alternate True Power Factor, Phase B	—	0.001	0 – 2,000 (-32,768 if N/A)	Derived using the complete harmonic content of real and apparent power (4-wire system only). Reported value is mapped from 0-2000, with 1000 representing unity, values below 1000 representing lagging, and values above 1000 representing leading.
1166	Alternate True Power Factor, Phase C	—	0.001	0 – 2,000 (-32,768 if N/A)	Derived using the complete harmonic content of real and apparent power (4-wire system only). Reported value is mapped from 0-2000, with 1000 representing unity, values below 1000 representing lagging, and values above 1000 representing leading.
1167	Alternate True Power Factor, Total	—	0.001	0 – 2,000	Derived using the complete harmonic content of real and apparent power. Reported value is mapped from 0-2000, with 1000 representing unity, values below 1000 representing lagging, and values above 1000 representing leading.
1168	Displacement Power Factor, Phase A	—	0.001	1,000 -200 to 200 (-32,768 if N/A)	Derived using only fundamental frequency of the real and apparent power. 4-wire system only
1169	Displacement Power Factor, Phase B	—	0.001	1,000 -200 to 200 (-32,768 if N/A)	Derived using only fundamental frequency of the real and apparent power. 4-wire system only
1170	Displacement Power Factor, Phase C	—	0.001	1,000 -200 to 200 (-32,768 if N/A)	Derived using only fundamental frequency of the real and apparent power. 4-wire system only

# Power Meter Register List

## Register List

**Table A-3: Abbreviated Register List**

Reg	Name	Scale	Units	Range	Notes
1171	Displacement Power Factor, Total	—	0.001	1,000 -200 to 200 (-32,768 if N/A)	Derived using only fundamental frequency of the real and apparent power
1172	Alternate Displacement Power Factor, Phase A	—	0.001	0 – 2,000 (-32,768 if N/A)	Derived using only fundamental frequency of the real and apparent power (4-wire system only). Reported value is mapped from 0-2000, with 1000 representing unity, values below 1000 representing lagging, and values above 1000 representing leading.
1173	Alternate Displacement Power Factor, Phase B	—	0.001	0 – 2,000 (-32,768 if N/A)	Derived using only fundamental frequency of the real and apparent power (4-wire system only). Reported value is mapped from 0-2000, with 1000 representing unity, values below 1000 representing lagging, and values above 1000 representing leading.
1174	Alternate Displacement Power Factor, Phase C	—	0.001	0 – 2,000 (-32,768 if N/A)	Derived using only fundamental frequency of the real and apparent power (4-wire system only). Reported value is mapped from 0-2000, with 1000 representing unity, values below 1000 representing lagging, and values above 1000 representing leading.
1175	Alternate Displacement Power Factor, Total	—	0.001	0 – 2,000	Derived using only fundamental frequency of the real and apparent power. Reported value is mapped from 0-2000, with 1000 representing unity, values below 1000 representing lagging, and values above 1000 representing leading.
<b>1s Metering — Frequency</b>					
1180	Frequency	—	0.01Hz  0.10Hz	(50/60Hz) 2,300 – 6,700 (400Hz) 3,500 – 4,500 (-32,768 if N/A)	Frequency of circuits being monitored. If the frequency is out of range, the register will be -32,768.
<b>Power Quality</b>					
<b>THD</b>					
1200	THD/thd Current, Phase A	—	0.10%	0 – 32,767	Total Harmonic Distortion, Phase A Current See register 3227 for THD/ thd definition

# Power Meter Register List

## Register List

**Table A-3: Abbreviated Register List**

Reg	Name	Scale	Units	Range	Notes
1201	THD/thd Current, Phase B	—	0.10%	0 – 32,767	Total Harmonic Distortion, Phase B Current See register 3227 for THD/ thd definition
1202	THD/thd Current, Phase C	—	0.10%	0 – 32,767	Total Harmonic Distortion, Phase C Current See register 3227 for THD/ thd definition
1203	THD/thd Current, Phase N	—	0.10%	0 – 32,767 (-32,768 if N/A)	Total Harmonic Distortion, Phase N Current (4-wire system only) See register 3227 for THD/ thd definition
1207	THD/thd Voltage, Phase A-N	—	0.10%	0 – 32,767 (-32,768 if N/A)	Total Harmonic Distortion Phase A-N (4-wire system only) See register 3227 for THD/ thd definition
1208	THD/thd Voltage, Phase B-N	—	0.10%	0 – 32,767 (-32,768 if N/A)	Total Harmonic Distortion Phase B-N (4-wire system only) See register 3227 for THD/ thd definition
1209	THD/thd Voltage, Phase C-N	—	0.10%	0 – 32,767 (-32,768 if N/A)	Total Harmonic Distortion Phase C-N (4-wire system only) See register 3227 for THD/ thd definition
1211	THD/thd Voltage, Phase A-B	—	0.10%	0 – 32,767	Total Harmonic Distortion Phase A-B See register 3227 for THD/ thd definition
1212	THD/thd Voltage, Phase B-C	—	0.10%	0 – 32,767	Total Harmonic Distortion Phase B-C See register 3227 for THD/ thd definition
1213	THD/thd Voltage, Phase C-A	—	0.10%	0 – 32,767	Total Harmonic Distortion Phase C-A See register 3227 for THD/ thd definition
<b>Fundamental Magnitudes and Angles</b>					
<b>Current</b>					
1230	Current Fundamental RMS Magnitude, Phase A	A	Amps/Scale	0 – 32,767	
1231	Current Fundamental Coincident Angle, Phase A	—	0.1°	0 – 3,599	Referenced to A-N/A-B Voltage Angle
1232	Current Fundamental RMS Magnitude, Phase B	A	Amps/Scale	0 – 32,767	

# Power Meter Register List

## Register List

**Table A-3: Abbreviated Register List**

Reg	Name	Scale	Units	Range	Notes
1233	Current Fundamental Coincident Angle, Phase B	—	0.1°	0 – 3,599	Referenced to A-N/A-B Voltage Angle
1234	Current Fundamental RMS Magnitude, Phase C	A	Amps/Scale	0 – 32,767	
1235	Current Fundamental Coincident Angle, Phase C	—	0.1°	0 – 3,599	Referenced to A-N/A-B Voltage Angle
1236	Current Fundamental RMS Magnitude, Neutral	B	Amps/Scale	0 – 32,767 (-32,768 if N/A)	4-wire system only
1237	Current Fundamental Coincident Angle, Neutral	—	0.1°	0 – 3,599 (-32,768 if N/A)	Referenced to A-N 4-wire system only
<b>Voltage</b>					
1244	Voltage Fundamental RMS Magnitude, A-N/A-B	D	Volts/Scale	0 – 32,767	Voltage A-N (4-wire system) Voltage A-B (3-wire system)
1245	Voltage Fundamental Coincident Angle, A-N/A-B	—	0.1°	0 – 3,599	Referenced to A-N (4-wire) or A-B (3-wire)
1246	Voltage Fundamental RMS Magnitude, B-N/B-C	D	Volts/Scale	0 – 32,767	Voltage B-N (4-wire system) Voltage B-C (3-wire system)
1247	Voltage Fundamental Coincident Angle, B-N/B-C	—	0.1°	0 – 3,599	Referenced to A-N (4-wire) or A-B (3-wire)
1248	Voltage Fundamental RMS Magnitude, C-N/C-A	D	Volts/Scale	0 – 32,767	Voltage C-N (4-wire system) Voltage C-A (3-wire system)
1249	Voltage Fundamental Coincident Angle, C-N/C-A	—	0.1°	0 – 3,599	Referenced to A-N (4-wire) or A-B (3-wire)
<b>Sequence Components</b>					
1284	Current, Positive Sequence, Magnitude	A	Amps/Scale	0 – 32,767	

# Power Meter Register List

## Register List

**Table A-3: Abbreviated Register List**

Reg	Name	Scale	Units	Range	Notes
1285	Current, Positive Sequence, Angle	—	0.1	0 – 3,599	
1286	Current, Negative Sequence, Magnitude	A	Amps/Scale	0 – 32,767	
1287	Current, Negative Sequence, Angle	—	0.1	0 – 3,599	
1288	Current, Zero Sequence, Magnitude	A	Amps/Scale	0 – 32,767	
1289	Current, Zero Sequence, Angle	—	0.1	0 – 3,599	
1290	Voltage, Positive Sequence, Magnitude	D	Volts/Scale	0 – 32,767	
1291	Voltage, Positive Sequence, Angle	—	0.1	0 – 3,599	
1292	Voltage, Negative Sequence, Magnitude	D	Volts/Scale	0 – 32,767	
1293	Voltage, Negative Sequence, Angle	—	0.1	0 – 3,599	
1294	Voltage, Zero Sequence, Magnitude	D	Volts/Scale	0 – 32,767	
1295	Voltage, Zero Sequence, Angle	—	0.1	0 – 3,599	
1296	Current, Sequence, Unbalance	—	0.10%	0 – 10,000	
1297	Voltage, Sequence, Unbalance	—	0.10%	0 – 10,000	
1298	Current, Sequence Unbalance Factor	—	0.10%	0 – 10,000	Negative Sequence / Positive Sequence
1299	Voltage, Sequence Unbalance Factor	—	0.10%	0 – 10,000	Negative Sequence / Positive Sequence

# Power Meter Register List

## Register List

**Table A-3: Abbreviated Register List**

Reg	Name	Scale	Units	Range	Notes
<b>Minimum/Maximum</b>					
<b>Preset Month Min/Max</b>					
1300	Min/Max Voltage L-L	—	—	—	See “Minimum/Maximum Template” on page 96
1310	Min/Max Voltage L-N	—	—	—	See “Minimum/Maximum Template” on page 96
1320	Min/Max Current	—	—	—	See “Minimum/Maximum Template” on page 96
1330	Min/Max Voltage L-L, Unbalance	—	—	—	See “Minimum/Maximum Template” on page 96
1340	Min/Max Voltage L-N Unbalance	—	—	—	See “Minimum/Maximum Template” on page 96
1350	Min/Max True Power Factor Total	—	—	—	See “Minimum/Maximum Template” on page 96
1360	Min/Max Displacement Power Factor Total	—	—	—	See “Minimum/Maximum Template” on page 96
1370	Min/Max Real Power Total	—	—	—	See “Minimum/Maximum Template” on page 96
1380	Min/Max Reactive Power Total	—	—	—	See “Minimum/Maximum Template” on page 96
1390	Min/Max Apparent Power Total	—	—	—	See “Minimum/Maximum Template” on page 96
1400	Min/Max THD/thd Voltage L-L	—	—	—	See “Minimum/Maximum Template” on page 96
1410	Min/Max THD/thd Voltage L-N	—	—	—	See “Minimum/Maximum Template” on page 96
1420	Min/Max THD/thd Current	—	—	—	See “Minimum/Maximum Template” on page 96
1430	Min/Max Frequency	—	—	—	See “Minimum/Maximum Template” on page 96
1440	Date/Time of last Present Month Min/Max Update	—	See Table A-1 on page 86	See Table A-1 on page 86	Date/Time of last Present Month Min/Max Update
<b>Previous Month Min/Max</b>					
1450	Min/Max Voltage L-L	—	—	—	See “Minimum/Maximum Template” on page 96
1460	Min/Max Voltage L-N	—	—	—	See “Minimum/Maximum Template” on page 96

# Power Meter Register List

## Register List

**Table A-3: Abbreviated Register List**

Reg	Name	Scale	Units	Range	Notes
1470	Min/Max Current	—	—	—	See "Minimum/Maximum Template" on page 96
1480	Min/Max Voltage L-L, Unbalance	—	—	—	See "Minimum/Maximum Template" on page 96
1490	Min/Max Voltage L-N Unbalance	—	—	—	See "Minimum/Maximum Template" on page 96
1500	Min/Max True Power Factor Total	—	—	—	See "Minimum/Maximum Template" on page 96
1510	Min/Max Displacement Power Factor Total	—	—	—	See "Minimum/Maximum Template" on page 96
1520	Min/Max Real Power Total	—	—	—	See "Minimum/Maximum Template" on page 96
1530	Min/Max Reactive Power Total	—	—	—	See "Minimum/Maximum Template" on page 96
1540	Min/Max Apparent Power Total	—	—	—	See "Minimum/Maximum Template" on page 96
1550	Min/Max THD/thd Voltage L-L	—	—	—	See "Minimum/Maximum Template" on page 96
1560	Min/Max THD/thd Voltage L-N	—	—	—	See "Minimum/Maximum Template" on page 96
1570	Min/Max THD/thd Current	—	—	—	See "Minimum/Maximum Template" on page 96
1580	Min/Max Frequency	—	—	—	See "Minimum/Maximum Template" on page 96
1590	Min/Max End Time	—	See "Minimum/Maximum Template" on page 96	See "Minimum/Maximum Template" on page 96	
<b>Minimum/Maximum Template</b>					
Base	Date/Time of Min	—	Table A-1 on page 86	Table A-1 on page 86	Date/Time when Min was recorded
Base+3	Min Value			0 – 32,767	Min value metered for all phases
Base+4	Phase of recorded Min*	—		1 to 3	Phase of Min recorded
Base+5	Date/Time of Max	—	Table A-1 on page 86	Table A-1 on page 86	Date/Time when Max was recorded
Base+8	Max Value			0 – 32,767	Max value metered for all phases
Base+9	Phase of recorded Max*	—		1 to 3	Phase of Max recorded
* Only applicable for multi-phase quantities					



# Power Meter Register List

## Register List

**Table A-3: Abbreviated Register List**

Reg	Name	Scale	Units	Range	Notes
<b>Energy</b>					
1700	Energy, Real In	—	WH	(1)	3-Phase total real energy into the load
1704	Energy, Reactive In	—	VArH	(1)	3-Phase total reactive energy into the load
1708	Energy, Real Out	—	WH	(1)	3-Phase total real energy out of the load
1712	Energy, Reactive Out	—	VArH	(1)	3-Phase total reactive energy out of the load
1716	Energy, Real Total (signed/absolute)	—	WH	(2)	Total Real Energy In, Out or In + Out
1720	Energy, Reactive Total (signed/absolute)	—	VArH	(2)	Total Reactive Energy In, Out or In + Out
1724	Energy, Apparent	—	VAH	(1)	3-Phase total apparent energy
1728	Energy, Conditional Real In	—	WH	(1)	3-Phase total accumulated conditional real energy into the load
1732	Energy, Conditional Reactive In	—	VArH	(1)	3-Phase total accumulated conditional reactive energy into the load
1736	Energy, Conditional Real Out	—	WH	(1)	3-Phase total accumulated conditional real energy out of the load
1740	Energy, Conditional Reactive Out	—	VArH	(1)	3-Phase total accumulated conditional reactive energy out of the load
1744	Energy, Conditional Apparent	—	VAH	(1)	3-Phase total accumulated conditional apparent energy
1748	Energy, Incremental Real In, Last Complete Interval	—	WH	(3)	3-Phase total accumulated incremental real energy into the load
1751	Energy, Incremental Reactive In, Last Complete Interval	—	VArH	(3)	3-Phase total accumulated incremental reactive energy into the load
1754	Energy, Incremental Real Out, Last Complete Interval	—	WH	(3)	3-Phase total accumulated incremental real energy out of the load
1757	Energy, Incremental Reactive Out, Last Complete Interval	—	VArH	(3)	3-Phase total accumulated incremental reactive energy out of the load
1760	Energy, Incremental Apparent, Last Complete Interval	—	VAH	(3)	3-Phase total accumulated incremental apparent energy
1763	Last Complete Interval DateTime	—	Table A-1 on page 86	Table A-1 on page 86	Date/Time of last completed incremental energy interval
1767	Energy, Incremental Real In, Present Interval	—	WH	(3)	3-Phase total accumulated incremental real energy into the load

# Power Meter Register List

## Register List

**Table A-3: Abbreviated Register List**

Reg	Name	Scale	Units	Range	Notes
1770	Energy, Incremental Reactive In, Present Interval	—	VArH	(3)	3-Phase total accumulated incremental reactive energy into the load
1773	Energy, Incremental Real Out, Present Interval	—	WH	(3)	3-Phase total accumulated incremental real energy out of the load
1776	Energy, Incremental Reactive Out, Present Interval	—	VArH	(3)	3-Phase total accumulated incremental reactive energy out of the load
1779	Energy, Incremental Apparent, Present Interval	—	VAH	(3)	3-Phase total accumulated incremental apparent energy
1782	Energy, Reactive, Quadrant 1	—	VArH	(3)	3-Phase total accumulated incremental reactive energy – quadrant 1
1785	Energy, Reactive, Quadrant 2	—	VArH	(3)	3-Phase total accumulated incremental reactive energy – quadrant 2
1788	Energy, Reactive, Quadrant 3	—	VArH	(3)	3-Phase total accumulated incremental reactive energy – quadrant 3
1791	Energy, Reactive, Quadrant 4	—	VArH	(3)	3-Phase total accumulated incremental reactive energy – quadrant 4
1794	Conditional Energy Control Status	—	—	0 – 1	0 = Off (default) 1 = On
(1) 0 – 9,999,999,999,999,999					
(2) -9,999,999,999,999,999 – 9,999,999,999,999,999					
(3) 0 – 999,999,999,999					

# Power Meter Register List

## Register List

**Table A-3: Abbreviated Register List**

Reg	Name	Scale	Units	Range	Notes
<b>Demand</b>					
<b>Demand — Current Demand System Configuration and Data</b>					
1800	Demand Calculation Mode Current	—	—	0 – 1024	0 = Thermal Demand (default) 1 = Timed Interval Sliding Block 2 = Timed Interval Block 4 = Timed Interval Rolling Block 8 = Input Synchronized Block 16 = Input Synchronized Rolling Block 32 = Command Synchronized Block 64 = Command Synchronized Rolling Block *128 = Clock Synchronized Block *256 = Clock Synchronized Rolling Block 512 = Slave to Power Demand Interval 1024 = Slave to Incremental Energy Interval  *Not supported in the PM810
1801	Demand Interval Current	—	Minutes	1 – 60	Default = 15
1802	Demand Subinterval Current	—	Minutes	1 – 60	Default = 1
1803	Demand Sensitivity Current	—	1%	1 – 99	Adjusts the sensitivity of the thermal demand calculation. Default = 90
1805	Short Demand Interval Current	—	Seconds	0 – 60	Sets the interval for a running average demand calculation of short duration. Default = 15
1806	Time Elapsed in Interval Current	—	Seconds	0 – 3,600	Time elapsed in the present demand interval.
1807	Time Elapsed in Subinterval Current	—	Seconds	0 – 3,600	Time elapsed in the present demand subinterval.
1808	Interval Count Current	—	1.0	0 – 32,767	Count of demand intervals. Rolls over at 32, 767.
1809	Subinterval Count Current	—	1.0	0 – 60	Count of demand subintervals. Rolls over at interval.

# Power Meter Register List

## Register List

**Table A-3: Abbreviated Register List**

Reg	Name	Scale	Units	Range	Notes
1810	Min/Max Reset Date/Time Current	—	Table A-1 on page 86	Table A-1 on page 86	Date/Time of last reset of Current Demand Min/Max demands
1814	Min/Max Reset Count Current	—	1.0	0 – 32,767	Count of Min/Max demand resets. Rolls over at 32,767.
1815	Demand System Status Current	—	—	0x0000 – 0x000F	Bit 00 = end of demand subinterval Bit 01 = end of demand interval Bit 02 = start of first complete interval Bit 03 = end of first complete interval
<b>Demand — Power Demand System Configuration and Data</b>					
1840	Demand Calculation Mode Power	—	—	0 – 1024	0 = Thermal Demand(t) 1 = Timed Interval Sliding Block 2 = Timed Interval Block 4 = Timed Interval Rolling Block 8 = Input Synchronized Block 16 = Input Synchronized Rolling Block 32 = Command Synchronized Block 64 = Command Synchronized Rolling Block *128 = Clock Synchronized Block *256 = Clock Synchronized Rolling Block 1024 = Slave to Incremental Energy Interval  *Not supported in the PM810
1841	Demand Interval Power	—	Minutes	1 – 60	Default = 15
1842	Demand Subinterval Power	—	Minutes	1 – 60	Default = 1
1843	Demand Sensitivity Power	—	1%	1 – 99	Adjusts the sensitivity of the thermal demand calculation. Default = 90
1844	Predicted Demand Sensitivity Power	—	1.0	1 – 10	Adjusts sensitivity of predicted demand calculation to recent changes in power consumption. Default = 5.
1845	Short Demand Interval Power	—	Seconds	0 – 60	Sets the interval for a running average demand calculation of short duration. Default = 15

# Power Meter Register List

## Register List

**Table A-3: Abbreviated Register List**

Reg	Name	Scale	Units	Range	Notes
1846	Time Elapsed in Interval Power	—	Seconds	0 – 3,600	Time elapsed in the present demand interval.
1847	Time Elapsed in Subinterval Power	—	Seconds	0 – 3,600	Time elapsed in the present demand subinterval.
1848	Interval Count Power	—	1.0	0 – 32,767	Count of demand intervals. Rolls over at 32,767.
1849	Subinterval Count Power	—	1.0	0 – 60	Count of demand subintervals. Rolls over at interval.
1850	Min/Max Reset Date/Time Power	—	Table A-1 on page 86	Table A-1 on page 86	Date/Time of last reset of Power Demand Min/Max demands
1854	Min/Max Reset Count Power	—	1.0	0 – 32,767	Count of Min/Max demand resets. Rolls over at 32,767.
1855	Demand System Status Power	—	—	0x0000 – 0x000F	Bit 00 = end of demand subinterval Bit 01 = end of demand interval Bit 02 = start of first complete interval Bit 03 = end of first complete interval
<b>Demand — Input Metering Demand System Configuration and Data</b>					
1860	Demand Calculation Mode Input Pulse Metering	—	—	0 – 1024	0 = Thermal Demand 1 = Timed Interval Sliding Block 2 = Timed Interval Block (default) 4 = Timed Interval Rolling Block 8 = Input Synchronized Block 16 = Input Synchronized Rolling Block 32 = Command Synchronized Block 64 = Command Synchronized Rolling Block *128 = Clock Synchronized Block *256 = Clock Synchronized Rolling Block 512 = Slave to Power Demand Interval 1024 = Slave to Incremental Energy Interval  *Not supported in the PM810

# Power Meter Register List

## Register List

**Table A-3: Abbreviated Register List**

Reg	Name	Scale	Units	Range	Notes
1861	Demand Interval Input Pulse Metering	—	Minutes	1 – 60	Default = 15
1862	Demand Subinterval Input Pulse Metering	—	Minutes	1 – 60	Default = 1
1863	Demand Sensitivity Input Pulse Metering	—	1%	1 – 99	Adjusts the sensitivity of the thermal demand calculation. Default = 90
1865	Short Demand Interval Input Pulse Metering	—	Seconds	0 – 60	Sets the interval for a running average demand calculation of short duration. Default = 15
1866	Time Elapsed in Interval Input Pulse Metering	—	Seconds	0 – 3,600	
1867	Time Elapsed in Subinterval Input Pulse Metering	—	Seconds	0 – 3,600	
1868	Interval Count Input Pulse Metering	—	1.0	0 – 32,767	Rolls over at 32,767.
1869	Subinterval Count Input Pulse Metering	—	1.0	0 – 60	Rolls over at interval.
1870	Min/Max Reset DateTime Input Pulse Metering	—	Table A-1 on page 86	Table A-1 on page 86	
1874	Min/Max Reset Count Input Pulse Metering	—	1.0	0 – 32,767	Rolls over at 32,767.
1875	Demand System Status Input Pulse Metering	—	—	0x0000 – 0x000F	Bit 00 = end of demand subinterval Bit 01 = end of demand interval Bit 02 = start of first complete interval Bit 03 = end of first complete interval

# Power Meter Register List

## Register List

**Table A-3: Abbreviated Register List**

Reg	Name	Scale	Units	Range	Notes
<b>Demand — Generic Demand System Configuration and Data</b>					
1880	Demand Calculation Mode Generic Group 1	—	—	0 – 1024	0 = Thermal Demand (default) 1 = Timed Interval Sliding Block 2 = Timed Interval Block 4 = Timed Interval Rolling Block 8 = Input Synchronized Block 16 = Input Synchronized Rolling Block 32 = Command Synchronized Block 64 = Command Synchronized Rolling Block *128 = Clock Synchronized Block *256 = Clock Synchronized Rolling Block 512 = Slave to Power Demand Interval 1024 = Slave to Incremental Energy Interval  *Not supported in the PM810
1881	Demand Interval Generic	—	Minutes	1 – 60	Default = 15
1882	Demand Subinterval Generic	—	Minutes	1 – 60	Default = 1
1883	Demand Sensitivity Generic	—	1%	1 – 99	Adjusts the sensitivity of the thermal demand calculation. Default = 90
1885	Short Demand Interval Generic	—	Seconds	0 – 60	Sets the interval for a running average demand calculation of short duration. Default = 15
1886	Time Elapsed in Interval Generic	—	Seconds	0 – 3,600	Time elapsed in the present demand interval.
1887	Time Elapsed in Subinterval Generic	—	Seconds	0 – 3,600	Time elapsed in the present demand subinterval.
1888	Interval Count Generic	—	1.0	0 – 32,767	Count of demand intervals. Rolls over at 32,767.
1889	Subinterval Count Generic	—	1.0	0 – 60	Count of demand subintervals. Rolls over at interval.

# Power Meter Register List

## Register List

**Table A-3: Abbreviated Register List**

Reg	Name	Scale	Units	Range	Notes
1890	Min/Max Reset Date/Time Generic	—	Table A-1 on page 86	Table A-1 on page 86	Date/Time of last reset of Generic Group 1 Demand Min/Max demands
1894	Min/Max Reset Count Generic	—	1.0	0 – 32,767	Count of Min/Max demand resets. Rolls over at 32,767.
1895	Demand System Status Generic	—	—	0x0000 – 0x000F	Bit 00 = end of demand subinterval Bit 01 = end of demand interval Bit 02 = start of first complete interval Bit 03 = end of first complete interval
<b>Demand — Miscellaneous Demand System Configuration and Data</b>					
1920	Demand Forgiveness Duration	—	Seconds	0 – 3,600	Duration of time after a power outage, during which power demand is not calculated
1921	Demand Forgiveness Outage Definition	—	Seconds	0 – 3,600	Duration of time that metered voltage must be lost to be considered a power outage for demand forgiveness
1923	Clock Sync Time of Day	—	Minutes	0 – 1,440	Time of day, in minutes from midnight, to which the demand interval is to be synchronized. Applies to demand intervals configured as Clock Synchronized.
1924	Power Factor Average Over Last Power Demand Interval	—	0.001	1,000 -100 – 100 (-32,768 if N/A)	
1925	Cumulative Demand Reset Date/Time	—	Table A-1 on page 86	Table A-1 on page 86	Date/Time of the last reset of cumulative demand
1929	Cumulative Input Pulse Metering Reset Date/Time	—	Table A-1 on page 86	Table A-1 on page 86	Date/Time of last reset of input pulse metering accumulation
1940	Last Incremental Interval, Real Demand Peak	F	kW/Scale	-32,767 – 32,767	Maximum real 3-phase power demand over the last incremental energy interval
1941	Last Incremental Interval, Real Demand Peak Date/Time	—	Table A-1 on page 86	Table A-1 on page 86	Date/Time of the Real Power Demand peak during the last completed incremental energy interval
1945	Last Incremental Interval, Reactive Demand Peak	F	kVAr/Scale	-32,767 – 32,767	Maximum reactive 3-phase power demand over the last incremental energy interval



# Power Meter Register List

## Register List

**Table A-3: Abbreviated Register List**

Reg	Name	Scale	Units	Range	Notes
1946	Last Incremental Interval, Reactive Demand Peak DateTime	—	Table A-1 on page 86	Table A-1 on page 86	Date/Time of the Reactive Power Demand peak during the last completed incremental energy interval
1950	Last Incremental Interval, Apparent Demand Peak	F	kVA/Scale	0 – 32,767	Maximum apparent 3-phase power demand over the last incremental energy interval
1951	Last Incremental Interval, Apparent Demand Peak DateTime	—	Table A-1 on page 86	Table A-1 on page 86	Date/Time of the Apparent Power Demand peak during the last completed incremental energy interval
<b>Demand — Current Demand Channels</b>					
1960	Last Demand Current, Phase A	A	Amps/Scale	0 – 32,767	Phase A current demand, last complete interval
1961	Present Demand Current, Phase A	A	Amps/Scale	0 – 32,767	Phase A current demand, present interval
1962	Running Average Demand Current, Phase A	A	Amps/Scale	0 – 32,767	Phase A current demand, running average demand calculation of short duration
1963	Peak Demand Current, Phase A	A	Amps/Scale	0 – 32,767	Phase A peak current demand
1964	Peak Demand DateTime Current, Phase A	—	Table A-1 on page 86	Table A-1 on page 86	Date/Time of Peak Current Demand, Phase A
1970	Last Demand Current, Phase B	A	Amps/Scale	0 – 32,767	Phase B current demand, last complete interval
1971	Present Demand Current, Phase B	A	Amps/Scale	0 – 32,767	Phase B current demand, present interval
1972	Running Average Demand Current, Phase B	A	Amps/Scale	0 – 32,767	Phase B current demand, running average demand calculation of short duration
1973	Peak Demand Current Phase B	A	Amps/Scale	0 – 32,767	Phase B peak current demand
1974	Peak Demand DateTime Current Phase B	—	Table A-1 on page 86	Table A-1 on page 86	Date/Time of Peak Current Demand, Phase B
1980	Last Demand Current, Phase C	A	Amps/Scale	0 – 32,767	Phase C current demand, last complete interval

# Power Meter Register List

## Register List

**Table A-3: Abbreviated Register List**

Reg	Name	Scale	Units	Range	Notes
1981	Present Demand Current, Phase C	A	Amps/Scale	0 – 32,767	Phase C current demand, present interval
1982	Running Average Demand Current, Phase C	A	Amps/Scale	0 – 32,767	Phase C current demand, running average demand calculation of short duration
1983	Peak Demand Current Phase C	A	Amps/Scale	0 – 32,767	Phase C peak current demand
1984	Peak Demand DateTime Current Phase C	—	Table A-1 on page 86	Table A-1 on page 86	Date/Time of Peak Current Demand, Phase C
1990	Last Demand Current, Neutral	A	Amps/Scale	0 – 32,767 (-32,768 if N/A)	Neutral current demand, last complete interval 4-wire system only
1991	Present Demand Current, Neutral	A	Amps/Scale	0 – 32,767 (-32,768 if N/A)	Neutral current demand, present interval 4-wire system only
1992	Running Average Demand Current, Neutral	A	Amps/Scale	0 – 32,767 (-32,768 if N/A)	Neutral current demand, running average demand calculation of short duration 4-wire system only
1993	Peak Demand Current, Neutral	A	Amps/Scale	0 – 32,767 (-32,768 if N/A)	Neutral peak current demand 4-wire system only
1994	Peak Demand DateTime Current, Neutral	—	Table A-1 on page 86	Table A-1 on page 86 (-32,768 if N/A)	Date/Time of Peak Current Demand, Neutral 4-wire system only
2000	Last Demand Current, 3-Phase Average	A	Amps/Scale	0 – 32,767	3-Phase Average current demand, last complete interval
2001	Present Demand Current, 3-Phase Average	A	Amps/Scale	0 – 32,767	3-Phase Average current demand, present interval
2002	Running Average Demand Current, 3-Phase Average	A	Amps/Scale	0 – 32,767	3-Phase Average current demand, short sliding block
2003	Peak Demand Current, 3-Phase Average	A	Amps/Scale	0 – 32,767	3-Phase Average peak current demand

# Power Meter Register List

## Register List

**Table A-3: Abbreviated Register List**

Reg	Name	Scale	Units	Range	Notes
2004	Peak Demand Date/Time  Current, 3-Phase Average	—	Table A-1 on page 86	Table A-1 on page 86	Date/Time of Peak Current Demand, 3-Phase Average
<b>Demand — Power Demand Channels</b>					
2150	Last Demand Real Power, 3-Phase Total	F	kW/Scale	-32,767 – 32,767	3-Phase total present real power demand for last completed demand interval – updated every sub-interval
2151	Present Demand Real Power, 3-Phase Total	F	kW/Scale	-32,767 – 32,767	3-Phase total present real power demand for present demand interval
2152	Running Average Demand Real Power, 3-Phase Total	F	kW/Scale	-32,767 – 32,767	Updated every second
2153	Predicted Demand Real Power, 3-Phase Total	F	kW/Scale	-32,767 – 32,767	Predicted real power demand at the end of the present interval
2154	Peak Demand Real Power, 3-Phase Total	F	kW/Scale	-32,767 – 32,767	
2155	Peak Demand Date/Time  Real Power, 3-Phase Total	—	Table A-1 on page 86	Table A-1 on page 86	
2159	Cumulative Demand Real Power, 3-Phase Total	F	kW/Scale	-2147483648 – 2147483647	
2161	Power Factor, Average @ Peak Demand, Real Power	—	0.001	1,000 -100 to 100 (-32,768 if N/A)	Average True Power Factor at the time of the Peak Real Demand
2162	Power Demand, Reactive @ Peak Demand, Real Power	F	kVAR/Scale	-32,767 – 32,767	Reactive Power Demand at the time of the Peak Real Demand
2163	Power Demand, Apparent @ Peak Demand, Real Power	F	kVA/Scale	0 – 32,767	Apparent Power Demand at the time of the Peak Real Demand

# Power Meter Register List

## Register List

**Table A-3: Abbreviated Register List**

Reg	Name	Scale	Units	Range	Notes
2165	Last Demand Reactive Power, 3- Phase Total	F	kVAr /Scale	-32,767 – 32,767	3-Phase total present reactive power demand for last completed demand interval – updated every sub-interval
2166	Present Demand Reactive Power, 3- Phase Total	F	kVAr /Scale	-32,767 – 32,767	3-Phase total present real power demand for present demand interval
2167	Running Average Demand Reactive Power, 3- Phase Total	F	kVAr /Scale	-32,767 – 32,767	3-Phase total present reactive power demand, running average demand calculation of short duration – updated every second
2168	Predicted Demand Reactive Power, 3- Phase Total	F	kVAr /Scale	-32,767 – 32,767	Predicted reactive power demand at the end of the present interval
2169	Peak Demand Reactive Power, 3- Phase Total	F	kVAr /Scale	-32,767 – 32,767	
2170	Peak Demand DateTime Reactive Power, 3- Phase Total	—	Table A-1 on page 86	Table A-1 on page 86	
2174	Cumulative Demand Reactive Power, 3- Phase Total	F	kVAr /Scale	-2147483648 – 2147483647	
2176	Power Factor, Average @ Peak Demand, Reactive Power	—	0.001	1,000 -100 to 100 (-32,768 if N/A)	Average True Power Factor at the time of the Peak Reactive Demand
2177	Power Demand, Real @ Peak Demand, Reactive Power	F	kW/Scale	-32,767 – 32,767	Real Power Demand at the time of the Peak Reactive Demand
2178	Power Demand, Apparent @ Peak Demand, Reactive Power	F	kVA/Scale	0 – 32,767	Apparent Power Demand at the time of the Peak Reactive Demand
2180	Last Demand Apparent Power 3- Phase Total	F	kVA /Scale	-32,767 – 32,767	3-Phase total present apparent power demand for last completed demand interval – updated every sub-interval
2181	Present Demand Apparent Power, 3- Phase Total	F	kVA /Scale	-32,767 – 32,767	3-Phase total present apparent power demand for present demand interval

# Power Meter Register List

## Register List

**Table A-3: Abbreviated Register List**

Reg	Name	Scale	Units	Range	Notes
2182	Running Average Demand Apparent Power, 3-Phase Total	F	kVA /Scale	-32,767 – 32,767	3-Phase total present apparent power demand, running average demand calculation of short duration – updated every second
2183	Predicted Demand Apparent Power, 3-Phase Total	F	kVA /Scale	-32,767 – 32,767	Predicted apparent power demand at the end of the present interval
2184	Peak Demand Apparent Power, 3-Phase Total	F	kVA /Scale	-32,767 – 32,767	3-Phase total peak apparent power demand peak
2185	Peak Demand Date/Time Apparent Power, 3-Phase Total	—	Table A-1 on page 86	Table A-1 on page 86	Date/Time of 3-Phase peak apparent power demand
2189	Cumulative Demand Apparent Power, 3-Phase Total	F	kVA /Scale	-2,147,483,648 – 2,147,483,647	Cumulative Demand, Apparent Power
2191	Power Factor, Average @ Peak Demand, Apparent Power	—	0.001	1,000 -100 to 100 (-32,768 if N/A)	Average True Power Factor at the time of the Peak Apparent Demand
2192	Power Demand, Real @ Peak Demand, Apparent Power	F	kW/Scale	-32,767 – 32,767	Real Power Demand at the time of the Peak Apparent Demand
2193	Power Demand, Reactive @ Peak Demand, Apparent Power	F	kVAr/Scale	0 – 32,767	Reactive Power Demand at the time of the Peak Apparent Demand
<b>Demand — Input Metering Demand Channels</b>					
2200	Consumption Units Code Input Channel #1	—	—	See Unit Codes	Units in which consumption is to be accumulated Default = 0
2201	Demand Units Code Input Channel #1	—	—	See Unit Codes	Units in which demand (rate) is to be expressed Default = 0
2202	Last Demand Input Channel #1	—	—	0 – 32,767	Last complete interval, updated every sub-interval
2203	Present Demand Input Channel #1	—	—	0 – 32,767	Present interval

# Power Meter Register List

## Register List

**Table A-3: Abbreviated Register List**

Reg	Name	Scale	Units	Range	Notes
2204	Running Average Demand Input Channel #1	—	———	0 – 32,767	Running average demand calculation of short duration, updated every second
2205	Peak Demand Input Channel #1	—	———	0 – 32,767	
2206	Peak Demand Date/Time Input Channel #1	—	Table A-1 on page 86	Table A-1 on page 86	
2210	Minimum Demand Input Channel #1	—	———	0 – 32,767	
2211	Minimum Demand Date/Time Input Channel #1	—	Table A-1 on page 86	Table A-1 on page 86	
2215	Cumulative Usage Input Channel #1	—	(2)	(1)	The user must identify the units to be used in the accumulation.
2220	Input Channel #2				Same as registers 2200 – 2219 except for Channel #2
2240	Input Channel #3				Same as registers 2200 – 2219 except for Channel #3
2260	Input Channel #4				Same as registers 2200 – 2219 except for Channel #4
2280	Input Channel #5				Same as registers 2200 – 2219 except for Channel #5
<b>Demand — Generic Group 1 Demand Channels</b>					
2400	Input Register Generic Channel #1	—	———	———	Register selected for generic demand calculation
2401	Unit Code Generic Channel #1	—	———	-32,767 – 32,767	Used by software
2402	Scale Code Generic Channel #1	—	———	-3 – 3	
2403	Last Demand Generic Channel #1	—	———	0 – 32,767	
2404	Present Demand Generic Channel #1	—	———	0 – 32,767	
2405	Running Average Demand Generic Channel #1	—	———	0 – 32,767	Updated every second

# Power Meter Register List

## Register List

**Table A-3: Abbreviated Register List**

Reg	Name	Scale	Units	Range	Notes
2406	Peak Demand Generic Channel #1	—	—	0 – 32,767	
2407	Peak Demand Date/Time Generic Channel #1	—	Table A-1 on page 86	Table A-1 on page 86	
2411	Minimum Demand Generic Channel #1	—	—	0 – 32,767	
2412	Minimum Demand Date/Time Generic Channel #1	—	Table A-1 on page 86	Table A-1 on page 86	
2420	Generic Channel #2				Same as registers 2400 – 2419 except for Channel #2
2440	Generic Channel #3				Same as registers 2400 – 2419 except for Channel #3
2460	Generic Channel #4				Same as registers 2400 – 2419 except for Channel #4
2480	Generic Channel #5				Same as registers 2400 – 2419 except for Channel #5
2500	Generic Channel #6				Same as registers 2400 – 2419 except for Channel #6
2520	Generic Channel #7				Same as registers 2400 – 2419 except for Channel #7
2540	Generic Channel #8				Same as registers 2400 – 2419 except for Channel #8
2560	Generic Channel #9				Same as registers 2400 – 2419 except for Channel #9
2580	Generic Channel #10				Same as registers 2400 – 2419 except for Channel #10
<b>Phase Extremes</b>					
2800	Current, Highest Phase Value	A	Amps/Scale	0 – 32,767	Highest value of Phases A, B, C or N
2801	Current, Lowest Phase Value	A	Amps/Scale	0 – 32,767	Lowest value of Phases A, B, C or N
2802	Voltage, L-L, Highest Value	D	Volts/Scale	0 – 32,767	Highest value of Phases A-B, B-C or C-A
2803	Voltage, L-L, Lowest Value	D	Volts/Scale	0 – 32,767	Lowest value of Phases A-B, B-C or C-A
2804	Voltage, L-N, Highest Value	D	Volts/Scale	0 – 32,767 (-32,768 if N/A)	Highest value of Phases A-N, B-N or C-N 4-wire system only

# Power Meter Register List

## Register List

**Table A-3: Abbreviated Register List**

Reg	Name	Scale	Units	Range	Notes
2805	Voltage, L-N, Lowest Value	D	Volts/Scale	0 – 32,767 (-32,768 if N/A)	Lowest value of Phases A-N, B-N or C-N 4-wire system only
<b>System Configuration</b>					
3002	Power Meter Nameplate	—	—	—	
3014	Power Meter Present Operating System Firmware Revision Level	—	—	0x0000 – 0xFFFF	
3034	Present Date/Time	—	Table A-1 on page 86	Table A-1 on page 86	
3039	Last Unit Restart	—	Table A-1 on page 86	Table A-1 on page 86	Last unit restart time
3043	Number of Metering System Restarts	—	1.0	0 – 32,767	
3044	Number of Control Power Failures	—	1.0	0 – 32,767	
3045	Control Power Failure Date/Time	—	Table A-1 on page 86	Table A-1 on page 86	Date/Time of last control power failure
3049	Cause of Last Meter Reset	—	—	1 – 20	1 = shutdown & soft reset (restart F/W) 2 = shutdown & hard reset (load from flash and run) 3 = shutdown & hard reset and set memory to default 10 = shutdown with no reset (used by DLF) 12 = already shutdown, hard reset only (used by DLF) 20 = Power failure *the value of NV register 11 is placed in here at reset.



# Power Meter Register List

## Register List

**Table A-3: Abbreviated Register List**

Reg	Name	Scale	Units	Range	Notes
3050	Self-Test Results	—	—	0x0000 – 0xFFFF	0 = Normal; 1 = Error  Bit 00 = Is set to "1" if any failure occurs Bit 01 = RTC failure Bit 02 = Reserved Bit 03 = Reserved Bit 04 = Reserved Bit 05 = Metering Collection overrun failure Bit 06 = Reserved Bit 07 = Metering Process 1.0 overrun failure Bit 08 = Reserved Bit 09 = Reserved Bit 10 = Reserved Bit 11 = Reserved Bit 12 = Reserved Bit 13 = Reserved Bit 14 = Reserved Bit 15 = Reserved

# Power Meter Register List

## Register List

**Table A-3: Abbreviated Register List**

Reg	Name	Scale	Units	Range	Notes
3051	Self Test Results	—	—	0x0000 – 0xFFFF	<p>0 = Normal; 1 = Error</p> <p>Bit 00 = tbd Aux IO failure</p> <p>Bit 01 = tbd Option Slot A module failure</p> <p>Bit 02 = tbd Option Slot B module failure</p> <p>Bit 03 = tbd IOX module failure</p> <p>Bit 04 =</p> <p>Bit 05 =</p> <p>Bit 06 =</p> <p>Bit 07 =</p> <p>Bit 08 = OS Create failure</p> <p>Bit 09 = OS Queue overrun failure</p> <p>Bit 10 =</p> <p>Bit 11 =</p> <p>Bit 12 =</p> <p>Bit 13 = Systems shut down due to continuous reset</p> <p>Bit 14 = Unit in Download, Condition A</p> <p>Bit 15 = Unit in Download, Condition B</p>
3052	Configuration Modified	—	—	0x0000 – 0xFFFF	<p>Used by sub-systems to indicate that a value used within that system has been internally modified</p> <p>0 = No modifications; 1 = Modifications</p> <p>Bit 00 = Summary bit</p> <p>Bit 01 = Metering System</p> <p>Bit 02 = Communications System</p> <p>Bit 03 = Alarm System</p> <p>Bit 04 = File System</p> <p>Bit 05 = Auxiliary IO System</p> <p>Bit 06 = Display System</p>

# Power Meter Register List

## Register List

**Table A-3: Abbreviated Register List**

Reg	Name	Scale	Units	Range	Notes
3055	Supported Feature Bitmap	—	—	—	Bitmap of supported features '1' (TRUE) = Bit 0 = Logging supported Bit 1 = FLASH Data-logs 2 & 3 Supported Bit 2 = WFC Supported Bit 3 = Disturbance Alarms Supported Bit 4 = Harmonics through the 31 <sup>st</sup> Supported Bit 5 = Harmonics through the 63 <sup>rd</sup> Supported Bit 6 = Real Time Clock Support Bit 7 = Boolean Alarms Supported Bit 8 = Configurable Alarms Supported Bit 9 = All Demand Models Supported
3093	Present Month	—	Months	1 – 12	
3094	Present Day	—	Days	1 – 31	
3095	Present Year	—	Years	2,000 – 2,043	
3096	Present Hour	—	Hours	0 – 23	
3097	Present Minute	—	Minutes	0 – 59	
3098	Present Second	—	Seconds	0 – 59	
3099	Day of Week	—	1.0	1 – 7	Sunday = 1
<b>Current/Voltage Configuration</b>					
3138	CT Ratio, Phase A Correction Factor	—	0.00001	-20,000 – 20,000	Default = 0
3139	CT Ratio, Phase B Correction Factor	—	0.00001	-20,000 – 20,000	Default = 0
3140	CT Ratio, Phase C Correction Factor	—	0.00001	-20,000 – 20,000	Default = 0
3142	PT Ratio, Phase A Correction Factor	—	0.00001	-20,000 – 20,000	Default = 0
3143	PT Ratio, Phase B Correction Factor	—	0.00001	-20,000 – 20,000	Default = 0
3144	PT Ratio, Phase C Correction Factor	—	0.00001	-20,000 – 20,000	Default = 0
3150	Field Calibration Date/Time	—	Table A-1 on page 86	Table A-1 on page 86	
3154	Phase A Current Field Calibration Coefficient	—	0.00001	-20,000 – 20,000	Default = 0

# Power Meter Register List

## Register List

**Table A-3: Abbreviated Register List**

Reg	Name	Scale	Units	Range	Notes
3155	Phase B Current Field Calibration Coefficient	—	0.00001	-20,000 – 20,000	Default = 0
3156	Phase C Current Field Calibration Coefficient	—	0.00001	-20,000 – 20,000	Default = 0
3158	Phase A Voltage Field Calibration Coefficient	—	0.00001	-20,000 – 20,000	Default = 0
3159	Phase B Voltage Field Calibration Coefficient	—	0.00001	-20,000 – 20,000	Default = 0
3160	Phase C Voltage Field Calibration Coefficient	—	0.00001	-20,000 – 20,000	Default = 0
3161	Neutral-Ground Voltage Field Calibration Coefficient	—	0.00001	-20,000 – 20,000	Default = 0
3170	CT Phase Shift Correction @ 1 amp	—	—	-1,000 – 1,000	Phase Shift Correction in the range of –10° to +10°. A negative shifts in the lag direction. Default = 0
3171	CT Phase Shift Correction @ 5 amps	—	—	-1,000 – 1,000	Phase Shift Correction in the range of –10° to +10°. A negative shifts in the lag direction. Default = 0
<b>Metering Configuration and Status</b>					
<b>Metering Configuration and Status — Basic</b>					
3200	Metering System Type	—	1.0	30, 31, 40, 42	30 = 3PH3W2CT 31 = 3PH3W3CT 40 = 3PH4W3CT (default) 42 = 3PH4W3CT2PT
3201	CT Ratio, 3-Phase Primary	—	1.0	1 – 32,767	Default = 5
3202	CT Ratio, 3-Phase Secondary	—	1.0	1, 5	Default = 5
3205	PT Ratio, 3-Phase Primary	—	1.0	1 – 32,767	Default = 120
3206	PT Ratio, 3-Phase Primary Scale Factor	—	1.0	-1 – 2	Default = 0 -1 = Direct Connect
3207	PT Ratio, 3-Phase Secondary	—	1.0	100, 110, 115, 120	Default = 120

# Power Meter Register List

## Register List

**Table A-3: Abbreviated Register List**

Reg	Name	Scale	Units	Range	Notes
3208	Nominal System Frequency	—	Hz	50, 60, 400	Default = 60
3209	Scale A – 3 Phase Amps	—	1.0	-2 – 1	Power of 10 Default = 0
3210	Scale B – Neutral Amps	—	1.0	-2 – 1	Power of 10 Default = 0
3212	Scale D – 3 Phase Volts	—	1.0	-1 – 2	Power of 10 Default = 0
3213	Scale E – Neutral Volts	—	1.0	-2 – 2	Power of 10 Default = -1
3214	Scale F – Power	—	1.0	-3 – 3	Power of 10 Default = 0
3227	Operating Mode Parameters	—	Binary	0x0000 – 0x0FFF	Default = 0  Bit 00 = Reserved Bit 01 = Reactive Energy & Demand Accumulation 0 = Fund. Only ; 1 = Harmonics Included Bit 02 = PF Sign Convention 0 = IEEE Convention 1 = IEC Convention Bit 03 = Reserved Bit 04 = Reserved Bit 05 = Reserved Bit 06 = Conditional Energy Accumulation Control 0 = Inputs; 1 = Command Bit 07 = Reserved Bit 08 = Display Setup 0 = Enabled; 1 = Disabled Bit 09 = Normal Phase Rotation 0 = ABC; 1 = CBA Bit 10 = Total Harmonic Distortion Calculation 0 = THD (% Fundamental) 1 = thd (% Total RMS) Bit 11 = Reserved

# Power Meter Register List

## Register List

**Table A-3: Abbreviated Register List**

Reg	Name	Scale	Units	Range	Notes
3228	Phase Rotation Direction	—	1.0	0 – 1	0 = ABC; 1 = CBA
3229	Incremental Energy Interval	—	Minutes	0 – 1440	Default = 60 0 = Continuous Accumulation
3230	Incremental Energy Interval Start Time	—	Minutes	0 – 1440	Minutes from midnight Default = 0
3231	Incremental Energy Interval End Time	—	Minutes	0 – 1440	Minutes from midnight Default = 1440
3232	Energy Accumulation Mode	—	1.0	0 – 1	0 = Absolute (default) 1 = Signed
3233	Peak Current Demand Over Last Year (currently not calculated)	—	Amps	0 – 32,767	Entered by the user for use in calculation of Total Demand Distortion. 0 = Calculation not performed (default)
<b>Metering Configuration and Status — Harmonics</b>					
3240	Harmonic Quantity Selection	—	1.0	0 – 3	0 = Disabled 1 = Harmonic magnitudes only (default) 2 = Harmonic magnitudes and angles
3241	Voltage Harmonic Magnitude Format	—	1.0	0 - 2	0 = % of Fundamental (default) 1 = % of RMS 2 = RMS
3242	Current Harmonic Magnitude Format	—	1.0	0 - 2	0 = % of Fundamental (default) 1 = % of RMS 2 = RMS
3243	Harmonic Refresh Interval	—	Seconds	10 – 60	Default = 30
3244	Time Remaining Until Harmonic Refresh	—	Seconds	10 – 60	The user may write to this register to stretch the hold time.

# Power Meter Register List

## Register List

**Table A-3: Abbreviated Register List**

Reg	Name	Scale	Units	Range	Notes
3245	Harmonic Channel Map	—	Binary	0x0000 – 0x7FFF	Bitmap indicating active Harmonic Channels 0 = Inactive; 1 = Active  Bit 00 = Vab Bit 01 = Vbc Bit 02 = Vca Bit 03 = Van Bit 04 = Vbn Bit 05 = Vcn Bit 06 = Reserved (Neutral to Ref) Bit 07 = Ia Bit 08 = Ib Bit 09 = Ic Bit 10 = In Bit 11-15 = Reserved
3246	Harmonic Report Status	—	1.0	0 – 1	0 = Processing (default) 1 = Holding
<b>Metering Configuration and Status — Diagnostics</b>					
3254	Metering System Diagnostic Summary	—	Binary	0x0000 – 0xFFFF	0 = Normal; 1 = Error  Bit 00 = Summary Bit (On if any other bit is on) Bit 01 = Configuration Error Bit 02 = Scaling Error Bit 03 = Phase Loss Bit 04 = Wiring Error Bit 05 = Incremental Energy may be incorrect due to meter reset Bit 06 = External Demand Sync Timeout

# Power Meter Register List

## Register List

**Table A-3: Abbreviated Register List**

Reg	Name	Scale	Units	Range	Notes
3255	Metering System Configuration Error Summary	—	Binary	0x0000 – 0xFFFF	<p>0 = Normal; 1 = Error</p> <p>Bit 00 = Summary Bit (On if any other bit is on)</p> <p>Bit 01 = Logical Configuration Error</p> <p>Bit 02 = Demand System Configuration Error</p> <p>Bit 03 = Energy System Configuration Error</p> <p>Bit 04 = Reserved</p> <p>Bit 05 = Metering Configuration Error</p>
3257	Wiring Error Detection 1	—	Binary	0x0000 – 0xFFFF	<p>0 = Normal; 1 = Error</p> <p>Bit 00 = Summary Bit (On if any other bit is on)</p> <p>Bit 01 = Wiring Check Aborted</p> <p>Bit 02 = System type setup error</p> <p>Bit 03 = Frequency out of range</p> <p>Bit 04 = No voltage</p> <p>Bit 05 = Voltage imbalance</p> <p>Bit 06 = Not enough load to check connections</p> <p>Bit 07 = Check meter configured for direct connect</p> <p>Bit 08 = All CT reverse polarity</p> <p>Bit 09 = Reserved</p> <p>Bit 10 = Reserved</p> <p>Bit 11 = Reserved</p> <p>Bit 12 = Reserved</p> <p>Bit 13 = Reserved</p> <p>Bit 14 = Phase rotation not as expected</p> <p>Bit 15 = Negative kW is usually abnormal</p>



# Power Meter Register List

## Register List

**Table A-3: Abbreviated Register List**

Reg	Name	Scale	Units	Range	Notes
3258	Wiring Error Detection 2	—	Binary	0x0000 – 0xFFFF	<p>0 = Normal; 1 = Error</p> <p>Bit 00 = Van magnitude error            Bit 01 = Vbn magnitude error            Bit 02 = Vcn magnitude error            Bit 03 = Vab magnitude error            Bit 04 = Vbc magnitude error            Bit 05 = Vca magnitude error            Bit 06 = Van angle not as expected            Bit 07 = Vbn angle not as expected            Bit 08 = Vcn angle not as expected            Bit 09 = Vab angle not as expected            Bit 10 = Vbc angle not as expected            Bit 11 = Vca angle not as expected            Bit 12 = Vbn is reversed polarity            Bit 13 = Vcn is reversed polarity            Bit 14 = Vbc is reversed polarity            Bit 15 = Vca is reversed polarity</p>
3259	Wiring Error Detection 3	—	Binary	0x0000 – 0xFFFF	<p>0 = Normal; 1 = Error</p> <p>Bit 00 = Move VTa to VTb            Bit 01 = Move VTb to VTc            Bit 02 = Move VTc to VTa            Bit 03 = Move VTa to VTc            Bit 04 = Move VTb to VTa            Bit 05 = Move VTc to VTb            Bit 06 = Reserved            Bit 07 = Reserved            Bit 08 = Reserved            Bit 09 = Reserved            Bit 10 = Ia is &lt; 1% of CT            Bit 11 = Ib is &lt; 1% of CT            Bit 12 = Ic is &lt; 1% of CT            Bit 13 = Ia angle not in expected range            Bit 14 = Ib angle not in expected range            Bit 15 = Ic angle not in expected range</p>

# Power Meter Register List

## Register List

**Table A-3: Abbreviated Register List**

Reg	Name	Scale	Units	Range	Notes
3260	Wiring Error Detection 4	—	Binary	0x0000 – 0xFFFF	<p>0 = Normal; 1 = Error</p> <p>Bit 00 = CTa reversed polarity            Bit 01 = CTb reversed polarity            Bit 02 = CTc reversed polarity            Bit 03 = Reserved            Bit 04 = Move CTa to CTb            Bit 05 = Move CTb to CTc            Bit 06 = Move CTc to Cta            Bit 07 = Move CTa to CTc            Bit 08 = Move CTb to Cta            Bit 09 = Move CTc to CTb            Bit 10 = Move CTa to CTb &amp; reverse polarity            Bit 11 = Move CTb to CTc &amp; reverse polarity            Bit 12 = Move CTc to CTa &amp; reverse polarity            Bit 13 = Move CTa to CTc &amp; reverse polarity            Bit 14 = Move CTb to CTa &amp; reverse polarity            Bit 15 = Move CTc to CTb &amp; reverse polarity</p>
3261	Scaling Error	—	Binary	0x0000 – 0x003F	<p>Indicates potential over range due to scaling error</p> <p>0 = Normal; 1 = Error</p> <p>Bit 00 = Summary Bit (On if any other bit is on)            Bit 01 = Scale A – Phase Current Error            Bit 02 = Scale B – Neutral Current Error            Bit 03 = Unused            Bit 04 = Scale D – Phase Voltage Error            Bit 05 = Scale E – Neutral Voltage Error            Bit 06 = Scale F – Power Error</p>

# Power Meter Register List

## Register List

**Table A-3: Abbreviated Register List**

Reg	Name	Scale	Units	Range	Notes
3262	Phase Loss Bitmap	—	Binary	0x0000 – 0x007F (-32,768 if N/A)	0 = OK; 1 = Phase Loss  Bit 00 = Summary Bit (On if any other bit is on) Bit 01 = Voltage Phase A Bit 02 = Voltage Phase B Bit 03 = Voltage Phase C Bit 04 = Current Phase A Bit 05 = Current Phase B Bit 06 = Current Phase C  This register is controlled by the voltage and current phase loss alarms. These alarms must be configured and enabled for this register to be populated.
<b>Metering Configuration and Status — Resets</b>					
3266	Previous Month Minimum/Maximum Start Date/Time	—	Table A-1 on page 86	Table A-1 on page 86	
3270	Present Month Minimum/Maximum Reset Date/Time	—	Table A-1 on page 86	Table A-1 on page 86	
3274	Accumulated Energy Reset Date/Time	—	Table A-1 on page 86	Table A-1 on page 86	
3278	Conditional Energy Reset Date/Time	—	Table A-1 on page 86	Table A-1 on page 86	
3282	Incremental Energy Reset Date/Time	—	Table A-1 on page 86	Table A-1 on page 86	
3286	Input Metering Accumulation Reset Date/Time	—	Table A-1 on page 86	Table A-1 on page 86	
3290	Accumulated Energy Preset Date/Time	—	Table A-1 on page 86	Table A-1 on page 86	

# Power Meter Register List

## Register List

Table A-3: Abbreviated Register List

Reg	Name	Scale	Units	Range	Notes
<b>Metering Configuration and Status — Waveform Capture Status</b>					
<b>Communications</b>					
<b>Communications — RS-485</b>					
3400	Protocol	—	—	0 – 2	0 = Modbus (default) 1 = Jbus
3401	Address	—	—	0 – 255	Valid Addresses: (Default = 1) Modbus: 0 – 247 Jbus: 0 – 255
3402	Baud Rate	—	—	0 – 5	3 = 9600 (default) 4 = 19200 5 = 38400
3403	Parity	—	—	0 – 2	0 = Even (default) 1 = Odd 2 = None
3410	Packets To This Unit	—	—	0 – 32,767	Number of valid messages addressed to this unit
3411	Packets To Other Units	—	—	0 – 32,767	Number of valid messages addressed to other units
3412	Packets With Invalid Address	—	—	0 – 32,767	Number of messages received with invalid address
3413	Packets With Bad CRC	—	—	0 – 32,767	Number of messages received with bad CRC
3414	Packets With Error	—	—	0 – 32,767	Number of messages received with errors
3415	Packets With Illegal Opcode	—	—	0 – 32,767	Number of messages received with an illegal opcode
3416	Packets With Illegal Register	—	—	0 – 32,767	Number of messages received with an illegal register
3417	Invalid Write Responses	—	—	0 – 32,767	Number of invalid write responses
3418	Packets With Illegal Counts	—	—	0 – 32,767	Number of messages received with an illegal count
3419	Packets With Frame Error	—	—	0 – 32,767	Number of messages received with a frame error
3420	Broadcast Messages	—	—	0 – 32,767	Number of broadcast messages received
3421	Number Of Exceptions	—	—	0 – 32,767	Number of exception replies

# Power Meter Register List

## Register List

**Table A-3: Abbreviated Register List**

Reg	Name	Scale	Units	Range	Notes
3422	Messages With Good CRC	—	—	0 – 32,767	Number of messages received with a good CRC
3423	Modbus Event Counter	—	—	0 – 32,767	Modbus Event Counter

**Table A-4: Registers for Alarm Logs**

Reg	Name	Scale	Units	Range	Notes
<b>Active Alarm Log</b>					
5850	Acknowledge/Relay/ Priority Entry 1	—	—		Bits 0 -7 = Alarm Number Bits 8 = Active/Inactive 0=active 1=inactive Bits 9-11 = Unused Bits 12-13 = Priority Bit 14 = relay (1 = association) Bit 15 = Alarm Acknowledge (1 = acknowledged)
5851	Unique Identifier	—	—	0 – 0xFFFFFFFF	Bits 00 – 07 = Level (0 – 9) Bits 08 – 15 = Alarm Type Bits 16 – 31 = Test Register
5853	Label	—	—	ASCII	16 Characters
5861	Pickup Value for Entry 1	A-F	Units/Scale	0 – 32,767	Does not apply to digital or unary alarms
5862	Pickup Date/Time Entry 1	—	Table A-1 on page 86	Table A-1 on page 86	
5865	Active Alarm Log Entry 2				Same as 5850 – 5864 except for entry 2
5880	Active Alarm Log Entry 3				Same as 5850 – 5864 except for entry 3
5895	Active Alarm Log Entry 4				Same as 5850 – 5864 except for entry 4
5910	Active Alarm Log Entry 5				Same as 5850 – 5864 except for entry 5
5925	Active Alarm Log Entry 6				Same as 5850 – 5864 except for entry 6
5940	Active Alarm Log Entry 7				Same as 5850 – 5864 except for entry 7
5955	Active Alarm Log Entry 8				Same as 5850 – 5864 except for entry 8

# Power Meter Register List

## Register List

**Table A-4: Registers for Alarm Logs**

Reg	Name	Scale	Units	Range	Notes
5970	Active Alarm Log Entry 9				Same as 5850 – 5864 except for entry 9
5985	Active Alarm Log Entry 10				Same as 5850 – 5864 except for entry 10
6000	Active Alarm Log Entry 11				Same as 5850 – 5864 except for entry 11
6015	Active Alarm Log Entry 12				Same as 5850 – 5864 except for entry 12
6030	Active Alarm Log Entry 13				Same as 5850 – 5864 except for entry 13
6045	Active Alarm Log Entry 14				Same as 5850 – 5864 except for entry 14
6060	Active Alarm Log Entry 15				Same as 5850 – 5864 except for entry 15
6075	Active Alarm Log Entry 16				Same as 5850 – 5864 except for entry 16
6090	Active Alarm Log Entry 17				Same as 5850 – 5864 except for entry 17
6105	Active Alarm Log Entry 18				Same as 5850 – 5864 except for entry 18
6120	Active Alarm Log Entry 19				Same as 5850 – 5864 except for entry 19
6135	Active Alarm Log Entry 20				Same as 5850 – 5864 except for entry 20
6150	Active Alarm Log Entry 21				Same as 5850 – 5864 except for entry 21
6165	Active Alarm Log Entry 22				Same as 5850 – 5864 except for entry 22
6180	Active Alarm Log Entry 23				Same as 5850 – 5864 except for entry 23
6195	Active Alarm Log Entry 24				Same as 5850 – 5864 except for entry 24
6210	Active Alarm Log Entry 25				Same as 5850 – 5864 except for entry 25
6225	Number of unacknowledged alarms in active alarm log	—	1.0	0 – 50	The number of active alarms added to the active alarm log since reset that have not been acknowledged
6226	Number of unacknowledged alarms in active alarm list	—	1.0	0 – 50	Number of the last 50 alarms since reset that have not been acknowledged

# Power Meter Register List

## Register List

**Table A-4: Registers for Alarm Logs**

Reg	Name	Scale	Units	Range	Notes
<b>Alarm History Log</b>					
6250	Acknowledge/Relay/ Priority Entry 1	—	—		Bits 0 -7 = Alarm Number Bits 8-11 = Unused Bits 12-13 = Priority Bit 14 = relay (1 = association) Bit 15 = Alarm Acknowledged
6251	Unique Identifier	—	—	0 – 0xFFFFFFFF	Bits 00 – 07 = Level (0 – 9) Bits 08 – 15 = Alarm Type Bits 16 – 31 = Test Register
6253	Label	—	—	ASCII	16 Characters
6261	Extreme Value for History Log Entry 1	A-F	Units/Scale	0 – 32,767	Does not apply to digital or unary alarms
6262	Dropout Date/Time Entry 1	—	Table A–1 on page 86	Table A–1 on page 86	
6265	Elapsed Seconds for History Log Entry 1	—	Seconds	0 – 2147483647	
6267	Alarm History Log Entry 2				Same as 6250 – 6266 except for entry 2
6284	Alarm History Log Entry 3				Same as 6250 – 6266 except for entry 3
6301	Alarm History Log Entry 4				Same as 6250 – 6266 except for entry 4
6318	Alarm History Log Entry 5				Same as 6250 – 6266 except for entry 5
6335	Alarm History Log Entry 6				Same as 6250 – 6266 except for entry 6
6352	Alarm History Log Entry 7				Same as 6250 – 6266 except for entry 7
6369	Alarm History Log Entry 8				Same as 6250 – 6266 except for entry 8
6386	Alarm History Log Entry 9				Same as 6250 – 6266 except for entry 9
6403	Alarm History Log Entry 10				Same as 6250 – 6266 except for entry 10
6420	Alarm History Log Entry 11				Same as 6250 – 6266 except for entry 11
6437	Alarm History Log Entry 12				Same as 6250 – 6266 except for entry 12
6454	Alarm History Log Entry 13				Same as 6250 – 6266 except for entry 13

# Power Meter Register List

## Register List

**Table A-4: Registers for Alarm Logs**

Reg	Name	Scale	Units	Range	Notes
6471	Alarm History Log Entry 14				Same as 6250 – 6266 except for entry 14
6488	Alarm History Log Entry 15				Same as 6250 – 6266 except for entry 15
6505	Alarm History Log Entry 16				Same as 6250 – 6266 except for entry 16
6522	Alarm History Log Entry 17				Same as 6250 – 6266 except for entry 17
6539	Alarm History Log Entry 18				Same as 6250 – 6266 except for entry 18
6556	Alarm History Log Entry 19				Same as 6250 – 6266 except for entry 19
6573	Alarm History Log Entry 20				Same as 6250 – 6266 except for entry 20
6590	Alarm History Log Entry 21				Same as 6250 – 6266 except for entry 21
6607	Alarm History Log Entry 22				Same as 6250 – 6266 except for entry 22
6624	Alarm History Log Entry 23				Same as 6250 – 6266 except for entry 23
6641	Alarm History Log Entry 24				Same as 6250 – 6266 except for entry 24
6658	Alarm History Log Entry 25				Same as 6250 – 6266 except for entry 25
6675	Number of unacknowledged alarms in alarm history log	—	1.0	0 – 50	The number of unacknowledged alarms added to the alarm history log since reset
6676	Lost Alarms	—	1.0	0 – 32767	Number of alarm pickups FIFO'd from the internal active alarm list before a correlating pickup received

**Table A-5: Registers for Alarm Position Counters**

Reg	Name	Scale	Units	Range	Notes
<b>Alarms</b>					
<b>Alarms --- System Status</b>					



# Power Meter Register List

## Register List

**Table A-5: Registers for Alarm Position Counters**

Reg	Name	Scale	Units	Range	Notes
10011	Active Alarm Map	—	Binary	0x0000 – 0xFFFF	0 = Inactive, 1 = Active  Bit00 = Alarm #01 Bit01 = Alarm #02 ..... etc.
10023	Active Alarm Status	—	Binary	0x0000 – 0x000F	Bit00 = 1 if any priority 1-3 alarm is active Bit01 = 1 if a "High" (1) priority alarm is active Bit02 = 1 if a "Medium" (2) priority alarm is active Bit03 = 1 if a "Low" (3) priority alarm is active
10024	Latched Active Alarm Status	—	Binary	0x0000 – 0x000F	Latched Active Alarms: (from the last time the register was cleared)  Bit00 = 1 if any priority 1-3 alarm is active Bit01 = 1 if a "High" (1) priority alarm is active Bit02 = 1 if a "Medium" (2) priority alarm is active Bit03 = 1 if a "Low" (3) priority alarm is active
10025	Total Counter	—	1.0	0 – 32,767	Total alarm counter, including all priorities 1, 2 and 3
10026	P3 Counter	—	1.0	0 – 32,767	Low alarm counter, all priority 3s
10027	P2 Counter	—	1.0	0 – 32,767	Medium alarm counter, all priority 2s
10028	P1 Counter	—	1.0	0 – 32,767	High alarm counter, all priority 1s
10029	Pickup Mode Selection	—	Binary	0x0 – 0xFFFF	Selection of absolute or relative pickup test for each of the alarm positions (if applicable, based on type)  Alarm #01 is least significant bit in register 10040  0 = Absolute (default) 1 = Relative  Bit00 = Alarm #01 Bit01 = Alarm #02 ..... etc.
10041	Number Of Samples In Relative Threshold Average	—	1.0	5 – 30	Number of 1-second update intervals used to compute the RMS average value used in relative pickup alarms (Default = 30)

# Power Meter Register List

## Register List

**Table A-5: Registers for Alarm Position Counters**

Reg	Name	Scale	Units	Range	Notes
<b>Alarms --- Counters</b>					
10115	Alarm Position #001 Counter	—	1.0	0 – 32,767	Standard Speed Alarm Position #001
10116	Alarm Position #002 Counter	—	1.0	0 – 32,767	Standard Speed Alarm Position #002
10117	Alarm Position #003 Counter	—	1.0	0 – 32,767	Standard Speed Alarm Position #003
10118	Alarm Position #004 Counter	—	1.0	0 – 32,767	Standard Speed Alarm Position #004
10119	Alarm Position #005 Counter	—	1.0	0 – 32,767	Standard Speed Alarm Position #005
10120	Alarm Position #006 Counter	—	1.0	0 – 32,767	Standard Speed Alarm Position #006
10121	Alarm Position #007 Counter	—	1.0	0 – 32,767	Standard Speed Alarm Position #007
10122	Alarm Position #008 Counter	—	1.0	0 – 32,767	Standard Speed Alarm Position #008
10123	Alarm Position #009 Counter	—	1.0	0 – 32,767	Standard Speed Alarm Position #009
10124	Alarm Position #010 Counter	—	1.0	0 – 32,767	Standard Speed Alarm Position #010
10125	Alarm Position #011 Counter	—	1.0	0 – 32,767	Standard Speed Alarm Position #011
10126	Alarm Position #012 Counter	—	1.0	0 – 32,767	Standard Speed Alarm Position #012
10127	Alarm Position #013 Counter	—	1.0	0 – 32,767	Standard Speed Alarm Position #013
10128	Alarm Position #014 Counter	—	1.0	0 – 32,767	Standard Speed Alarm Position #014
10129	Alarm Position #015 Counter	—	1.0	0 – 32,767	Standard Speed Alarm Position #015
10130	Alarm Position #016 Counter	—	1.0	0 – 32,767	Standard Speed Alarm Position #016
10131	Alarm Position #017 Counter	—	1.0	0 – 32,767	Standard Speed Alarm Position #017
10132	Alarm Position #018 Counter	—	1.0	0 – 32,767	Standard Speed Alarm Position #018
10133	Alarm Position #019 Counter	—	1.0	0 – 32,767	Standard Speed Alarm Position #019
10134	Alarm Position #020 Counter	—	1.0	0 – 32,767	Standard Speed Alarm Position #020

# Power Meter Register List

## Register List

**Table A-5: Registers for Alarm Position Counters**

Reg	Name	Scale	Units	Range	Notes
10135	Alarm Position #021 Counter	—	1.0	0 – 32,767	Standard Speed Alarm Position #021
10136	Alarm Position #022 Counter	—	1.0	0 – 32,767	Standard Speed Alarm Position #022
10137	Alarm Position #023 Counter	—	1.0	0 – 32,767	Standard Speed Alarm Position #023
10138	Alarm Position #024 Counter	—	1.0	0 – 32,767	Standard Speed Alarm Position #024
10139	Alarm Position #025 Counter	—	1.0	0 – 32,767	Standard Speed Alarm Position #025
10140	Alarm Position #026 Counter	—	1.0	0 – 32,767	Standard Speed Alarm Position #026
10141	Alarm Position #027 Counter	—	1.0	0 – 32,767	Standard Speed Alarm Position #027
10142	Alarm Position #028 Counter	—	1.0	0 – 32,767	Standard Speed Alarm Position #028
10143	Alarm Position #029 Counter	—	1.0	0 – 32,767	Standard Speed Alarm Position #029
10144	Alarm Position #030 Counter	—	1.0	0 – 32,767	Standard Speed Alarm Position #030
10145	Alarm Position #031 Counter	—	1.0	0 – 32,767	Standard Speed Alarm Position #031
10146	Alarm Position #032 Counter	—	1.0	0 – 32,767	Standard Speed Alarm Position #032
10147	Alarm Position #033 Counter	—	1.0	0 – 32,767	Standard Speed Alarm Position #033
10148	Alarm Position #034 Counter	—	1.0	0 – 32,767	Standard Speed Alarm Position #034
10149	Alarm Position #035 Counter	—	1.0	0 – 32,767	Standard Speed Alarm Position #035
10150	Alarm Position #036 Counter	—	1.0	0 – 32,767	Standard Speed Alarm Position #036
10151	Alarm Position #037 Counter	—	1.0	0 – 32,767	Standard Speed Alarm Position #037
10152	Alarm Position #038 Counter	—	1.0	0 – 32,767	Standard Speed Alarm Position #038
10153	Alarm Position #039 Counter	—	1.0	0 – 32,767	Standard Speed Alarm Position #039
10154	Alarm Position #040 Counter	—	1.0	0 – 32,767	Standard Speed Alarm Position #040
10155	Alarm Position #041 Counter	—	1.0	0 – 32,767	Standard Speed Alarm Position #041

# Power Meter Register List

## Register List

**Table A-5: Registers for Alarm Position Counters**

Reg	Name	Scale	Units	Range	Notes
10156	Alarm Position #042 Counter	—	1.0	0 – 32,767	Standard Speed Alarm Position #042
10157	Alarm Position #043 Counter	—	1.0	0 – 32,767	Standard Speed Alarm Position #043
10158	Alarm Position #044 Counter	—	1.0	0 – 32,767	Standard Speed Alarm Position #044
10159	Alarm Position #045 Counter	—	1.0	0 – 32,767	Standard Speed Alarm Position #045
10160	Alarm Position #046 Counter	—	1.0	0 – 32,767	Standard Speed Alarm Position #046
10161	Alarm Position #047 Counter	—	1.0	0 – 32,767	Standard Speed Alarm Position #047
10162	Alarm Position #048 Counter	—	1.0	0 – 32,767	Standard Speed Alarm Position #048
10163	Alarm Position #049 Counter	—	1.0	0 – 32,767	Standard Speed Alarm Position #049
10164	Alarm Position #050 Counter	—	1.0	0 – 32,767	Standard Speed Alarm Position #050
10165	Alarm Position #051 Counter	—	1.0	0 – 32,767	Standard Speed Alarm Position #051
10166	Alarm Position #052 Counter	—	1.0	0 – 32,767	Standard Speed Alarm Position #052
10167	Alarm Position #053 Counter	—	1.0	0 – 32,767	Standard Speed Alarm Position #053
10168	Alarm Position #054 Counter	—	1.0	0 – 32,767	Standard Speed Alarm Position #054
10169	Alarm Position #055 Counter	—	1.0	0 – 32,767	Standard Speed Alarm Position #055
10170	Alarm Position #056 Counter	—	1.0	0 – 32,767	Standard Speed Alarm Position #056
10171	Alarm Position #057 Counter	—	1.0	0 – 32,767	Standard Speed Alarm Position #057
10172	Alarm Position #058 Counter	—	1.0	0 – 32,767	Standard Speed Alarm Position #058
10173	Alarm Position #059 Counter	—	1.0	0 – 32,767	Standard Speed Alarm Position #059
10174	Alarm Position #060 Counter	—	1.0	0 – 32,767	Standard Speed Alarm Position #060
10175	Alarm Position #061 Counter	—	1.0	0 – 32,767	Standard Speed Alarm Position #061
10176	Alarm Position #062 Counter	—	1.0	0 – 32,767	Standard Speed Alarm Position #062

# Power Meter Register List

## Register List

**Table A-5: Registers for Alarm Position Counters**

Reg	Name	Scale	Units	Range	Notes
10177	Alarm Position #063Counter	—	1.0	0 – 32,767	Standard Speed Alarm Position #063
10178	Alarm Position #064Counter	—	1.0	0 – 32,767	Standard Speed Alarm Position #064
10179	Alarm Position #065 Counter	—	1.0	0 – 32,767	Standard Speed Alarm Position #065
10180	Alarm Position #066 Counter	—	1.0	0 – 32,767	Standard Speed Alarm Position #066
10181	Alarm Position #067 Counter	—	1.0	0 – 32,767	Standard Speed Alarm Position #067
10182	Alarm Position #068 Counter	—	1.0	0 – 32,767	Standard Speed Alarm Position #068
10183	Alarm Position #069 Counter	—	1.0	0 – 32,767	Standard Speed Alarm Position #069
10184	Alarm Position #070 Counter	—	1.0	0 – 32,767	Standard Speed Alarm Position #070
10185	Alarm Position #071 Counter	—	1.0	0 – 32,767	Standard Speed Alarm Position #071
10186	Alarm Position #072 Counter	—	1.0	0 – 32,767	Standard Speed Alarm Position #072
10187	Alarm Position #073Counter	—	1.0	0 – 32,767	Standard Speed Alarm Position #073
10188	Alarm Position #074 Counter	—	1.0	0 – 32,767	Standard Speed Alarm Position #074
<b>Alarms --- Standard Speed</b>					
10200	Alarm Position #001	—	See "Alarms --- Template 1" on page 141	See "Alarms --- Template 1" on page 141	Standard Speed Alarm Position #001 -See "Alarms --- Template 1" on page 141
10220	Alarm Position #002	—	See "Alarms --- Template 1" on page 141	See "Alarms --- Template 1" on page 141	Standard Speed Alarm Position #002 - See "Alarms --- Template 1" on page 141
10240	Alarm Position #003	—	See "Alarms --- Template 1" on page 141	See "Alarms --- Template 1" on page 141	Standard Speed Alarm Position #003 - See "Alarms --- Template 1" on page 141
10260	Alarm Position #004	—	See "Alarms --- Template 1" on page 141	See "Alarms --- Template 1" on page 141	Standard Speed Alarm Position #004 - See "Alarms --- Template 1" on page 141

# Power Meter Register List

## Register List

**Table A-5: Registers for Alarm Position Counters**

Reg	Name	Scale	Units	Range	Notes
10280	Alarm Position #005	—	See "Alarms --- Template 1" on page 141	See "Alarms --- Template 1" on page 141	Standard Speed Alarm Position #005 - See "Alarms --- Template 1" on page 141
10300	Alarm Position #006	—	See "Alarms --- Template 1" on page 141	See "Alarms --- Template 1" on page 141	Standard Speed Alarm Position #006 - See "Alarms --- Template 1" on page 141
10320	Alarm Position #007	—	See "Alarms --- Template 1" on page 141	See "Alarms --- Template 1" on page 141	Standard Speed Alarm Position #007 - See "Alarms --- Template 1" on page 141
10340	Alarm Position #008	—	See "Alarms --- Template 1" on page 141	See "Alarms --- Template 1" on page 141	Standard Speed Alarm Position #008 - See "Alarms --- Template 1" on page 141
10360	Alarm Position #009	—	See "Alarms --- Template 1" on page 141	See "Alarms --- Template 1" on page 141	Standard Speed Alarm Position #009 - See "Alarms --- Template 1" on page 141
10380	Alarm Position #010	—	See "Alarms --- Template 1" on page 141	See "Alarms --- Template 1" on page 141	Standard Speed Alarm Position #010 - See "Alarms --- Template 1" on page 141
10400	Alarm Position #011	—	See "Alarms --- Template 1" on page 141	See "Alarms --- Template 1" on page 141	Standard Speed Alarm Position #011 - See "Alarms --- Template 1" on page 141
10420	Alarm Position #012	—	See "Alarms --- Template 1" on page 141	See "Alarms --- Template 1" on page 141	Standard Speed Alarm Position #012 - See "Alarms --- Template 1" on page 141
10440	Alarm Position #013	—	See "Alarms --- Template 1" on page 141	See "Alarms --- Template 1" on page 141	Standard Speed Alarm Position #013 - See "Alarms --- Template 1" on page 141

# Power Meter Register List

## Register List

**Table A-5: Registers for Alarm Position Counters**

Reg	Name	Scale	Units	Range	Notes
10460	Alarm Position #014	—	See "Alarms --- Template 1" on page 141	See "Alarms --- Template 1" on page 141	Standard Speed Alarm Position #014 - See "Alarms --- Template 1" on page 141
10480	Alarm Position #015	—	See "Alarms --- Template 1" on page 141	See "Alarms --- Template 1" on page 141	Standard Speed Alarm Position #015 - See "Alarms --- Template 1" on page 141
10500	Alarm Position #016	—	See "Alarms --- Template 1" on page 141	See "Alarms --- Template 1" on page 141	Standard Speed Alarm Position #016 - See "Alarms --- Template 1" on page 141
10520	Alarm Position #017	—	See "Alarms --- Template 1" on page 141	See "Alarms --- Template 1" on page 141	Standard Speed Alarm Position #017 - See "Alarms --- Template 1" on page 141
10540	Alarm Position #018	—	See "Alarms --- Template 1" on page 141	See "Alarms --- Template 1" on page 141	Standard Speed Alarm Position #018 - See "Alarms --- Template 1" on page 141
10560	Alarm Position #019	—	See "Alarms --- Template 1" on page 141	See "Alarms --- Template 1" on page 141	Standard Speed Alarm Position #019 - See "Alarms --- Template 1" on page 141
10580	Alarm Position #020	—	See "Alarms --- Template 1" on page 141	See "Alarms --- Template 1" on page 141	Standard Speed Alarm Position #020 - See "Alarms --- Template 1" on page 141
10600	Alarm Position #021	—	See "Alarms --- Template 1" on page 141	See "Alarms --- Template 1" on page 141	Standard Speed Alarm Position #021 - See "Alarms --- Template 1" on page 141
10620	Alarm Position #022	—	See "Alarms --- Template 1" on page 141	See "Alarms --- Template 1" on page 141	Standard Speed Alarm Position #022 - See "Alarms --- Template 1" on page 141

# Power Meter Register List

## Register List

**Table A-5: Registers for Alarm Position Counters**

Reg	Name	Scale	Units	Range	Notes
10640	Alarm Position #023	—	See "Alarms --- Template 1" on page 141	See "Alarms --- Template 1" on page 141	Standard Speed Alarm Position #023 - See "Alarms --- Template 1" on page 141
10660	Alarm Position #024	—	See "Alarms --- Template 1" on page 141	See "Alarms --- Template 1" on page 141	Standard Speed Alarm Position #024 - See "Alarms --- Template 1" on page 141
10680	Alarm Position #025	—	See "Alarms --- Template 1" on page 141	See "Alarms --- Template 1" on page 141	Standard Speed Alarm Position #025 - See "Alarms --- Template 1" on page 141
10700	Alarm Position #026	—	See "Alarms --- Template 1" on page 141	See "Alarms --- Template 1" on page 141	Standard Speed Alarm Position #026 - See "Alarms --- Template 1" on page 141
10720	Alarm Position #027	—	See "Alarms --- Template 1" on page 141	See "Alarms --- Template 1" on page 141	Standard Speed Alarm Position #027 - See "Alarms --- Template 1" on page 141
10740	Alarm Position #028	—	See "Alarms --- Template 1" on page 141	See "Alarms --- Template 1" on page 141	Standard Speed Alarm Position #028 - See "Alarms --- Template 1" on page 141
10760	Alarm Position #029	—	See "Alarms --- Template 1" on page 141	See "Alarms --- Template 1" on page 141	Standard Speed Alarm Position #029 - See "Alarms --- Template 1" on page 141
10780	Alarm Position #030	—	See "Alarms --- Template 1" on page 141	See "Alarms --- Template 1" on page 141	Standard Speed Alarm Position #030 - See "Alarms --- Template 1" on page 141
10800	Alarm Position #031	—	See "Alarms --- Template 1" on page 141	See "Alarms --- Template 1" on page 141	Standard Speed Alarm Position #031 - See "Alarms --- Template 1" on page 141



# Power Meter Register List

## Register List

**Table A-5: Registers for Alarm Position Counters**

Reg	Name	Scale	Units	Range	Notes
10820	Alarm Position #032	—	See "Alarms --- Template 1" on page 141	See "Alarms --- Template 1" on page 141	Standard Speed Alarm Position #032 - See "Alarms --- Template 1" on page 141
10840	Alarm Position #033	—	See "Alarms --- Template 1" on page 141	See "Alarms --- Template 1" on page 141	Standard Speed Alarm Position #033 - See "Alarms --- Template 1" on page 141
10860	Alarm Position #034	—	See "Alarms --- Template 1" on page 141	See "Alarms --- Template 1" on page 141	Standard Speed Alarm Position #034 - See "Alarms --- Template 1" on page 141
10880	Alarm Position #035	—	See "Alarms --- Template 1" on page 141	See "Alarms --- Template 1" on page 141	Standard Speed Alarm Position #035 - See "Alarms --- Template 1" on page 141
10900	Alarm Position #036	—	See "Alarms --- Template 1" on page 141	See "Alarms --- Template 1" on page 141	Standard Speed Alarm Position #036 - See "Alarms --- Template 1" on page 141
10920	Alarm Position #037	—	See "Alarms --- Template 1" on page 141	See "Alarms --- Template 1" on page 141	Standard Speed Alarm Position #037 - See "Alarms --- Template 1" on page 141
10940	Alarm Position #038	—	See "Alarms --- Template 1" on page 141	See "Alarms --- Template 1" on page 141	Standard Speed Alarm Position #038 - See "Alarms --- Template 1" on page 141
10960	Alarm Position #039	—	See "Alarms --- Template 1" on page 141	See "Alarms --- Template 1" on page 141	Standard Speed Alarm Position #039 - See "Alarms --- Template 1" on page 141
10980	Alarm Position #040	—	See "Alarms --- Template 1" on page 141	See "Alarms --- Template 1" on page 141	Standard Speed Alarm Position #040 - See "Alarms --- Template 1" on page 141

# Power Meter Register List

## Register List

Table A-5: Registers for Alarm Position Counters

Reg	Name	Scale	Units	Range	Notes
<b>Alarms --- Digital</b>					
11240	Alarm Position #053	—	See "Alarms --- Template 1" on page 141	See "Alarms --- Template 1" on page 141	Standard Speed Alarm Position #053 - See "Alarms --- Template 1" on page 141
11260	Alarm Position #054	—	See "Alarms --- Template 1" on page 141	See "Alarms --- Template 1" on page 141	Standard Speed Alarm Position #054 - See "Alarms --- Template 1" on page 141
11280	Alarm Position #055	—	See "Alarms --- Template 1" on page 141	See "Alarms --- Template 1" on page 141	Standard Speed Alarm Position #055 - See "Alarms --- Template 1" on page 141
11300	Alarm Position #056	—	See "Alarms --- Template 1" on page 141	See "Alarms --- Template 1" on page 141	Standard Speed Alarm Position #056- See "Alarms --- Template 1" on page 141
11320	Alarm Position #057	—	See "Alarms --- Template 1" on page 141	See "Alarms --- Template 1" on page 141	Standard Speed Alarm Position #057 - See "Alarms --- Template 1" on page 141
11340	Alarm Position #058	—	See "Alarms --- Template 1" on page 141	See "Alarms --- Template 1" on page 141	Standard Speed Alarm Position #058 - See "Alarms --- Template 1" on page 141
11360	Alarm Position #059	—	See "Alarms --- Template 1" on page 141	See "Alarms --- Template 1" on page 141	Standard Speed Alarm Position #059 - See "Alarms --- Template 1" on page 141
11380	Alarm Position #060	—	See "Alarms --- Template 1" on page 141	See "Alarms --- Template 1" on page 141	Standard Speed Alarm Position #060 - See "Alarms --- Template 1" on page 141
11400	Alarm Position #061	—	See "Alarms --- Template 1" on page 141	See "Alarms --- Template 1" on page 141	Standard Speed Alarm Position #061 - See "Alarms --- Template 1" on page 141

# Power Meter Register List

## Register List

**Table A-5: Registers for Alarm Position Counters**

Reg	Name	Scale	Units	Range	Notes
11420	Alarm Position #062	—	See "Alarms --- Template 1" on page 141	See "Alarms --- Template 1" on page 141	Standard Speed Alarm Position #062 - See "Alarms --- Template 1" on page 141
11440	Alarm Position #063	—	See "Alarms --- Template 1" on page 141	See "Alarms --- Template 1" on page 141	Standard Speed Alarm Position #063 - See "Alarms --- Template 1" on page 141
11460	Alarm Position #064	—	See "Alarms --- Template 1" on page 141	See "Alarms --- Template 1" on page 141	Standard Speed Alarm Position #064 - See "Alarms --- Template 1" on page 141
<b>Alarms --- Boolean</b>					
11480	Alarm Position #065	—	See "Alarms --- Template 2" on page 142	See "Alarms --- Template 2" on page 142	Standard Speed Alarm Position #065 - See "Alarms --- Template 2" on page 142
11500	Alarm Position #066	—	See "Alarms --- Template 2" on page 142	See "Alarms --- Template 2" on page 142	Standard Speed Alarm Position #066 - See "Alarms --- Template 2" on page 142
11520	Alarm Position #067	—	See "Alarms --- Template 2" on page 142	See "Alarms --- Template 2" on page 142	Standard Speed Alarm Position #067 - See "Alarms --- Template 2" on page 142
11540	Alarm Position #068	—	See "Alarms --- Template 2" on page 142	See "Alarms --- Template 2" on page 142	Standard Speed Alarm Position #068 - See "Alarms --- Template 2" on page 142
11560	Alarm Position #069	—	See "Alarms --- Template 2" on page 142	See "Alarms --- Template 2" on page 142	Standard Speed Alarm Position #069 - See "Alarms --- Template 2" on page 142
11580	Alarm Position #070	—	See "Alarms --- Template 2" on page 142	See "Alarms --- Template 2" on page 142	Standard Speed Alarm Position #070 - See "Alarms --- Template 2" on page 142

# Power Meter Register List

## Register List

**Table A-5: Registers for Alarm Position Counters**

Reg	Name	Scale	Units	Range	Notes
11600	Alarm Position #071	—	See "Alarms --- Template 2" on page 142	See "Alarms --- Template 2" on page 142	Standard Speed Alarm Position #071 - See "Alarms --- Template 2" on page 142
11620	Alarm Position #072	—	See "Alarms --- Template 2" on page 142	See "Alarms --- Template 2" on page 142	Standard Speed Alarm Position #072 - See "Alarms --- Template 2" on page 142
11640	Alarm Position #073	—	See "Alarms --- Template 2" on page 142	See "Alarms --- Template 2" on page 142	Standard Speed Alarm Position #073 - See "Alarms --- Template 2" on page 142
11660	Alarm Position #074	—	See "Alarms --- Template 2" on page 142	See "Alarms --- Template 2" on page 142	Standard Speed Alarm Position #074 - See "Alarms --- Template 2" on page 142

# Power Meter Register List

## Register List

**Table A-5: Registers for Alarm Position Counters**

Reg	Name	Scale	Units	Range	Notes
<b>Alarms --- Template 1</b>					
Base	Unique Identifier	—	—	0 – 0xFFFFFFFF	Bits 00 – 07 = Level (0 – 9) Bits 08 – 15 = Alarm Type Bits 16 – 31 = Test Register For Disturbance alarms Test Register is: 1 = Vab 2 = Vbc 3 = Vca 4 = Van 5 = Vbn 6 = Vcn 7 = Vng 8 = Ia 9 = Ib 10 = Ic 11 = In  For Unary Alarms, Test Register is: 1 = End of Incremental Energy Interval 2 = End of Power Demand Interval 3 = End of 1s Meter Update Cycle 4 = Reserved 5 = Power up/ Reset
Base +2	Enable/Disable, Priority	—	—	MSB: 0 – FF LSB: 0 – 3	MSB: 0x00 = Disabled (Default) 0xFF = Enabled  LSB: Specifies the priority level 0 – 3
Base +3	Label	—	—	ASCII	16 Characters
Base +11	Pickup Value	A-F	Units/Scale	0 – 32,767	Does not apply to digital or unary alarms
Base +12	Pickup Delay	—	1s 100ms Cycle	0 – 32,767 0 – 999 0 – 999	Standard Speed Alarms High Speed Alarms Disturbance Alarms Does not apply to digital or unary alarms.
Base +13	Dropout Value	A-F —	Units/Scale	0 – 32,767	Does not apply to digital or unary alarms.

# Power Meter Register List

## Register List

**Table A-5: Registers for Alarm Position Counters**

Reg	Name	Scale	Units	Range	Notes
Base +14	Dropout Delay	—	1s 100ms Cycle	0 – 32,767 0 – 999 0 – 999	Standard Speed Alarms High Speed Alarms Disturbance Alarms Does not apply to digital or unary alarms.
Base +15	Reserved	—	—	—	Reserved for future development
Base +16	Datalog Specifier	—	—	0 – 0xFFFFFFFF	Bit 00 = Datalog #1 Bit 01 = Datalog #2 Bit 02 = Datalog #3
<b>Alarms --- Template 2</b>					
Base	Unique Identifier	—	—	0 – 0xFFFFFFFF	Bits 00 – 07 = Level (0 – 9) Bits 08 – 15 = Alarm Type Bits 16 – 31 = Test Register
Base +2	Enable/Disable, Priority	—	—	MSB: 0 – FF LSB: 0 – 3	MSB: 0x00 = Disable; 0xFF = Enable LSB: Specifies the priority level 0 – 3
Base +3	Label	—	—	ASCII	16 Characters
Base +11	Alarm test list	—	—	0 – 74	Alarm test list (position # in the normal alarm list)

**Table A-6: Spectral Components**

Reg	Name	Scale	Units	Range	Notes
<b>Spectral Components</b>					
<b>Spectral Components --- Harmonic Magnitudes and Angles</b>					
13200	Harmonic Magnitudes and Angles, Voltage A-B	—	See "Spectral Components - -- Data Template" on page 143	See "Spectral Components -- - Data Template" on page 143	See "Spectral Components --- Data Template" on page 143
13328	Harmonic Magnitudes and Angles, Voltage B-C	—	See "Spectral Components - -- Data Template" on page 143	See "Spectral Components -- - Data Template" on page 143	See "Spectral Components --- Data Template" on page 143
13456	Harmonic Magnitudes and Angles, Voltage C-A	—	See "Spectral Components - -- Data Template" on page 143	See "Spectral Components -- - Data Template" on page 143	See "Spectral Components --- Data Template" on page 143

# Power Meter Register List

## Register List

**Table A-6: Spectral Components**

Reg	Name	Scale	Units	Range	Notes
13584	Harmonic Magnitudes and Angles, Voltage A-N	—	See "Spectral Components -- Data Template" on page 143	See "Spectral Components -- Data Template" on page 143	See "Spectral Components --- Data Template" on page 143
13712	Harmonic Magnitudes and Angles, Voltage B-N	—	See "Spectral Components -- Data Template" on page 143	See "Spectral Components -- Data Template" on page 143	See "Spectral Components --- Data Template" on page 143
13840	Harmonic Magnitudes and Angles, Voltage C-N	—	See "Spectral Components -- Data Template" on page 143	See "Spectral Components -- Data Template" on page 143	See "Spectral Components --- Data Template" on page 143
13968	Harmonic Magnitudes and Angles, Voltage N-G	—	See "Spectral Components -- Data Template" on page 143	See "Spectral Components -- Data Template" on page 143	See "Spectral Components --- Data Template" on page 143
14096	Harmonic Magnitudes and Angles, Current, Phase A	—	See "Spectral Components -- Data Template" on page 143	See "Spectral Components -- Data Template" on page 143	See "Spectral Components --- Data Template" on page 143
14224	Harmonic Magnitudes and Angles, Current, Phase B	—	See "Spectral Components -- Data Template" on page 143	See "Spectral Components -- Data Template" on page 143	See "Spectral Components --- Data Template" on page 143
14352	Harmonic Magnitudes and Angles, Current, Phase C	—	See "Spectral Components -- Data Template" on page 143	See "Spectral Components -- Data Template" on page 143	See "Spectral Components --- Data Template" on page 143
14480	Harmonic Magnitudes and Angles, Current, Neutral	—	See "Spectral Components -- Data Template" on page 143	See "Spectral Components -- Data Template" on page 143	See "Spectral Components --- Data Template" on page 143
<b>Spectral Components --- Data Template</b>					
Base	Reference Magnitude	—	Volts/Scale Amps/Scale	0 – 32,767 (-32,768 if N/A)	Magnitude of fundamental or of overall RMS value upon which harmonic percentages are based.  Selection of format based on value in register 3241 or 3242. A selection of 2 (RMS) will cause a value of -32768 to be Entered.

# Power Meter Register List

## Register List

**Table A-6: Spectral Components**

Reg	Name	Scale	Units	Range	Notes
Base +1	Scale Factor	—	1.0	-3 – 3 (-32,768 if N/A)	Power of 10
Base +2	H1 Magnitude	% D,E A,B	.01 Volts/Scale Amps/Scale	0 – 10000 0 – 32,767 0 – 32,767	Magnitude of harmonic expressed as a percentage of the reference value, or as an absolute value.
Base +3	H1 Angle	—	0.1 °	0 – 3,599 (-32,678 if N/A)	Angle of 1st harmonic referenced to fundamental Voltage A-N (4-wire) or Voltage A-B (3-wire).
Base +4	H2 Magnitude	% D,E A,B	.01 Volts/Scale Amps/Scale	0 – 10000 0 – 32,767 0 – 32,767	Magnitude of harmonic expressed as a percentage of the reference value, or as an absolute value.
Base +5	H2 Angle	—	0.1 °	0 – 3,599 (-32,678 if N/A)	Angle of 2nd harmonic referenced to fundamental Voltage A-N (4-wire) or Voltage A-B (3-wire).
Base +6	H3 Magnitude	% D,E A,B	.01 Volts/Scale Amps/Scale	0 – 10000 0 – 32,767 0 – 32,767	Magnitude of harmonic expressed as a percentage of the reference value, or as an absolute value.
Base +7	H3 Angle	—	0.1 °	0 – 3,599 (-32,678 if N/A)	Angle of 3rd harmonic referenced to fundamental Voltage A-N (4-wire) or Voltage A-B (3-wire).
Base +8	H4 Magnitude	% D,E A,B	.01 Volts/Scale Amps/Scale	0 – 10000 0 – 32,767 0 – 32,767	Magnitude of harmonic expressed as a percentage of the reference value, or as an absolute value.
Base +9	H4 Angle	—	0.1 °	0 – 3,599 (-32,678 if N/A)	Angle of 4th harmonic referenced to fundamental Voltage A-N (4-wire) or Voltage A-B (3-wire).
Base +10	H5 Magnitude	% D,E A,B	.01 Volts/Scale Amps/Scale	0 – 10000 0 – 32,767 0 – 32,767	Magnitude of harmonic expressed as a percentage of the reference value, or as an absolute value.
Base +11	H5 Angle	—	0.1 °	0 – 3,599 (-32,678 if N/A)	Angle of 5th harmonic referenced to fundamental Voltage A-N (4-wire) or Voltage A-B (3-wire).
Base +12	H6 Magnitude	% D,E A,B	.01 Volts/Scale Amps/Scale	0 – 10000 0 – 32,767 0 – 32,767	Magnitude of harmonic expressed as a percentage of the reference value, or as an absolute value.
Base +13	H6 Angle	—	0.1 °	0 – 3,599 (-32,678 if N/A)	Angle of 6th harmonic referenced to fundamental Voltage A-N (4-wire) or Voltage A-B (3-wire).



# Power Meter Register List

## Register List

**Table A-6: Spectral Components**

Reg	Name	Scale	Units	Range	Notes
Base +14	H7 Magnitude	% D,E A,B	.01 Volts/Scale Amps/Scale	0 – 10000 0 – 32,767 0 – 32,767	Magnitude of harmonic expressed as a percentage of the reference value, or as an absolute value.
Base +15	H7 Angle	—	0.1 °	0 – 3,599 (-32,678 if N/A)	Angle of 7th harmonic referenced to fundamental Voltage A-N (4-wire) or Voltage A-B (3-wire).
Base +16	H8 Magnitude	% D,E A,B	.01 Volts/Scale Amps/Scale	0 – 10000 0 – 32,767 0 – 32,767	Magnitude of harmonic expressed as a percentage of the reference value, or as an absolute value.
Base +17	H8 Angle	—	0.1 °	0 – 3,599 (-32,678 if N/A)	Angle of 8th harmonic referenced to fundamental Voltage A-N (4-wire) or Voltage A-B (3-wire).
Base +18	H9 Magnitude	% D,E A,B	.01 Volts/Scale Amps/Scale	0 – 10000 0 – 32,767 0 – 32,767	Magnitude of harmonic expressed as a percentage of the reference value, or as an absolute value.
Base +19	H9 Angle	—	0.1 °	0 – 3,599 (-32,678 if N/A)	Angle of 9th harmonic referenced to fundamental Voltage A-N (4-wire) or Voltage A-B (3-wire).
Base +20	H10 Magnitude	% D,E A,B	.01 Volts/Scale Amps/Scale	0 – 10000 0 – 32,767 0 – 32,767	Magnitude of harmonic expressed as a percentage of the reference value, or as an absolute value.
Base +21	H10 Angle	—	0.1 °	0 – 3,599 (-32,678 if N/A)	Angle of 10th harmonic referenced to fundamental Voltage A-N (4-wire) or Voltage A-B (3-wire).
Base +22	H11 Magnitude	% D,E A,B	.01 Volts/Scale Amps/Scale	0 – 10000 0 – 32,767 0 – 32,767	Magnitude of harmonic expressed as a percentage of the reference value, or as an absolute value.
Base +23	H11 Angle	—	0.1 °	0 – 3,599 (-32,678 if N/A)	Angle of 11th harmonic referenced to fundamental Voltage A-N (4-wire) or Voltage A-B (3-wire).
Base +24	H12 Magnitude	% D,E A,B	.01 Volts/Scale Amps/Scale	0 – 10000 0 – 32,767 0 – 32,767	Magnitude of harmonic expressed as a percentage of the reference value, or as an absolute value.
Base +25	H12 Angle	—	0.1 °	0 – 3,599 (-32,678 if N/A)	Angle of 12th harmonic referenced to fundamental Voltage A-N (4-wire) or Voltage A-B (3-wire).
Base +26	H13 Magnitude	% D,E A,B	.01 Volts/Scale Amps/Scale	0 – 10000 0 – 32,767 0 – 32,767	Magnitude of harmonic expressed as a percentage of the reference value, or as an absolute value.

# Power Meter Register List

## Register List

**Table A-6: Spectral Components**

Reg	Name	Scale	Units	Range	Notes
Base + 27	H13 Angle	—	0.1 °	0 – 3,599 (-32,678 if N/A)	Angle of 13th harmonic referenced to fundamental Voltage A-N (4-wire) or Voltage A-B (3-wire).
Base + 28	H14 Magnitude	% D,E A,B	.01 Volts/Scale Amps/Scale	0 – 10000 0 – 32,767 0 – 32,767	Magnitude of harmonic expressed as a percentage of the reference value, or as an absolute value.
Base + 29	H14 Angle	—	0.1 °	0 – 3,599 (-32,678 if N/A)	Angle of 14th harmonic referenced to fundamental Voltage A-N (4-wire) or Voltage A-B (3-wire).
Base + 30	H15 Magnitude	% D,E A,B	.01 Volts/Scale Amps/Scale	0 – 10000 0 – 32,767 0 – 32,767	Magnitude of harmonic expressed as a percentage of the reference value, or as an absolute value.
Base + 31	H15 Angle	—	0.1 °	0 – 3,599 (-32,678 if N/A)	Angle of 15th harmonic referenced to fundamental Voltage A-N (4-wire) or Voltage A-B (3-wire).
Base + 32	H16 Magnitude	% D,E A,B	.01 Volts/Scale Amps/Scale	0 – 10000 0 – 32,767 0 – 32,767	Magnitude of harmonic expressed as a percentage of the reference value, or as an absolute value.
Base + 33	H16 Angle	—	0.1 °	0 – 3,599 (-32,678 if N/A)	Angle of 16th harmonic referenced to fundamental Voltage A-N (4-wire) or Voltage A-B (3-wire).
Base + 34	H17 Magnitude	% D,E A,B	.01 Volts/Scale Amps/Scale	0 – 10000 0 – 32,767 0 – 32,767	Magnitude of harmonic expressed as a percentage of the reference value, or as an absolute value.
Base + 35	H17 Angle	—	0.1 °	0 – 3,599 (-32,678 if N/A)	Angle of 17th harmonic referenced to fundamental Voltage A-N (4-wire) or Voltage A-B (3-wire).
Base + 36	H18 Magnitude	% D,E A,B	.01 Volts/Scale Amps/Scale	0 – 10000 0 – 32,767 0 – 32,767	Magnitude of harmonic expressed as a percentage of the reference value, or as an absolute value.
Base + 37	H18 Angle	—	0.1 °	0 – 3,599 (-32,678 if N/A)	Angle of 18th harmonic referenced to fundamental Voltage A-N (4-wire) or Voltage A-B (3-wire).
Base + 38	H19 Magnitude	% D,E A,B	.01 Volts/Scale Amps/Scale	0 – 10000 0 – 32,767 0 – 32,767	Magnitude of harmonic expressed as a percentage of the reference value, or as an absolute value.
Base + 39	H19 Angle	—	0.1 °	0 – 3,599 (-32,678 if N/A)	Angle of 19th harmonic referenced to fundamental Voltage A-N (4-wire) or Voltage A-B (3-wire).

# Power Meter Register List

## Register List

**Table A-6: Spectral Components**

Reg	Name	Scale	Units	Range	Notes
Base + 40	H20 Magnitude	% D,E A,B	.01 Volts/Scale Amps/Scale	0 – 10000 0 – 32,767 0 – 32,767	Magnitude of harmonic expressed as a percentage of the reference value, or as an absolute value.
Base + 41	H20 Angle	—	0.1 °	0 – 3,599 (-32,678 if N/A)	Angle of 20th harmonic referenced to fundamental Voltage A-N (4-wire) or Voltage A-B (3-wire).
Base + 42	H21 Magnitude	% D,E A,B	.01 Volts/Scale Amps/Scale	0 – 10000 0 – 32,767 0 – 32,767	Magnitude of harmonic expressed as a percentage of the reference value, or as an absolute value.
Base + 43	H21 Angle	—	0.1 °	0 – 3,599 (-32,678 if N/A)	Angle of 21st harmonic referenced to fundamental Voltage A-N (4-wire) or Voltage A-B (3-wire).
Base + 44	H22 Magnitude	% D,E A,B	.01 Volts/Scale Amps/Scale	0 – 10000 0 – 32,767 0 – 32,767	Magnitude of harmonic expressed as a percentage of the reference value, or as an absolute value.
Base + 45	H22 Angle	—	0.1 °	0 – 3,599 (-32,678 if N/A)	Angle of 22nd harmonic referenced to fundamental Voltage A-N (4-wire) or Voltage A-B (3-wire).
Base + 46	H23 Magnitude	% D,E A,B	.01 Volts/Scale Amps/Scale	0 – 10000 0 – 32,767 0 – 32,767	Magnitude of harmonic expressed as a percentage of the reference value, or as an absolute value.
Base + 47	H23 Angle	—	0.1 °	0 – 3,599 (-32,678 if N/A)	Angle of 23rd harmonic referenced to fundamental Voltage A-N (4-wire) or Voltage A-B (3-wire).
Base + 48	H24 Magnitude	% D,E A,B	.01 Volts/Scale Amps/Scale	0 – 10000 0 – 32,767 0 – 32,767	Magnitude of harmonic expressed as a percentage of the reference value, or as an absolute value.
Base + 49	H24 Angle	—	0.1 °	0 – 3,599 (-32,678 if N/A)	Angle of 24th harmonic referenced to fundamental Voltage A-N (4-wire) or Voltage A-B (3-wire).
Base + 50	H25 Magnitude	% D,E A,B	.01 Volts/Scale Amps/Scale	0 – 10000 0 – 32,767 0 – 32,767	Magnitude of harmonic expressed as a percentage of the reference value, or as an absolute value.
Base + 51	H25 Angle	—	0.1 °	0 – 3,599 (-32,678 if N/A)	Angle of 25th harmonic referenced to fundamental Voltage A-N (4-wire) or Voltage A-B (3-wire).
Base + 52	H26 Magnitude	% D,E A,B	.01 Volts/Scale Amps/Scale	0 – 10000 0 – 32,767 0 – 32,767	Magnitude of harmonic expressed as a percentage of the reference value, or as an absolute value.

# Power Meter Register List

## Register List

**Table A-6: Spectral Components**

Reg	Name	Scale	Units	Range	Notes
Base + 53	H26 Angle	—	0.1 °	0 – 3,599 (-32,678 if N/A)	Angle of 26th harmonic referenced to fundamental Voltage A-N (4-wire) or Voltage A-B (3-wire).
Base + 54	H27 Magnitude	% D,E A,B	.01 Volts/Scale Amps/Scale	0 – 10000 0 – 32,767 0 – 32,767	Magnitude of harmonic expressed as a percentage of the reference value, or as an absolute value.
Base + 55	H27 Angle	—	0.1 °	0 – 3,599 (-32,678 if N/A)	Angle of 27th harmonic referenced to fundamental Voltage A-N (4-wire) or Voltage A-B (3-wire).
Base + 56	H28 Magnitude	% D,E A,B	.01 Volts/Scale Amps/Scale	0 – 10000 0 – 32,767 0 – 32,767	Magnitude of harmonic expressed as a percentage of the reference value, or as an absolute value.
Base + 57	H28 Angle	—	0.1 °	0 – 3,599 (-32,678 if N/A)	Angle of 28th harmonic referenced to fundamental Voltage A-N (4-wire) or Voltage A-B (3-wire).
Base + 58	H29 Magnitude	% D,E A,B	.01 Volts/Scale Amps/Scale	0 – 10000 0 – 32,767 0 – 32,767	Magnitude of harmonic expressed as a percentage of the reference value, or as an absolute value.
Base + 59	H29 Angle	—	0.1 °	0 – 3,599 (-32,678 if N/A)	Angle of 29th harmonic referenced to fundamental Voltage A-N (4-wire) or Voltage A-B (3-wire).
Base + 60	H30 Magnitude	% D,E A,B	.01 Volts/Scale Amps/Scale	0 – 10000 0 – 32,767 0 – 32,767	Magnitude of harmonic expressed as a percentage of the reference value, or as an absolute value.
Base + 61	H30 Angle	—	0.1 °	0 – 3,599 (-32,678 if N/A)	Angle of 30th harmonic referenced to fundamental Voltage A-N (4-wire) or Voltage A-B (3-wire).
Base + 62	H31 Magnitude	% D,E A,B	.01 Volts/Scale Amps/Scale	0 – 10000 0 – 32,767 0 – 32,767	Magnitude of harmonic expressed as a percentage of the reference value, or as an absolute value.
Base + 63	H31 Angle	—	0.1 °	0 – 3,599 (-32,678 if N/A)	Angle of 31st harmonic referenced to fundamental Voltage A-N (4-wire) or Voltage A-B (3-wire).
Base + 64	H32 Magnitude	% D,E A,B	.01 Volts/Scale Amps/Scale	0 – 10000 0 – 32,767 0 – 32,767	Magnitude of harmonic expressed as a percentage of the reference value, or as an absolute value.
Base + 65	H32 Angle	—	0.1 °	0 – 3,599 (-32,678 if N/A)	Angle of 32nd harmonic referenced to fundamental Voltage A-N (4-wire) or Voltage A-B (3-wire).

# Power Meter Register List

## Register List

**Table A-6: Spectral Components**

Reg	Name	Scale	Units	Range	Notes
Base + 66	H33 Magnitude	% D,E A,B	.01 Volts/Scale Amps/Scale	0 – 10000 0 – 32,767 0 – 32,767	Magnitude of harmonic expressed as a percentage of the reference value, or as an absolute value.
Base + 67	H33 Angle	—	0.1 °	0 – 3,599 (-32,678 if N/A)	Angle of 33rd harmonic referenced to fundamental Voltage A-N (4-wire) or Voltage A-B (3-wire).
Base + 68	H34 Magnitude	% D,E A,B	.01 Volts/Scale Amps/Scale	0 – 10000 0 – 32,767 0 – 32,767	Magnitude of harmonic expressed as a percentage of the reference value, or as an absolute value.
Base + 69	H34 Angle	—	0.1 °	0 – 3,599 (-32,678 if N/A)	Angle of 34th harmonic referenced to fundamental Voltage A-N (4-wire) or Voltage A-B (3-wire).
Base + 70	H35 Magnitude	% D,E A,B	.01 Volts/Scale Amps/Scale	0 – 10000 0 – 32,767 0 – 32,767	Magnitude of harmonic expressed as a percentage of the reference value, or as an absolute value.
Base + 71	H35 Angle	—	0.1 °	0 – 3,599 (-32,678 if N/A)	Angle of 35th harmonic referenced to fundamental Voltage A-N (4-wire) or Voltage A-B (3-wire).
Base + 72	H36 Magnitude	% D,E A,B	.01 Volts/Scale Amps/Scale	0 – 10000 0 – 32,767 0 – 32,767	Magnitude of harmonic expressed as a percentage of the reference value, or as an absolute value.
Base + 73	H36 Angle	—	0.1 °	0 – 3,599 (-32,678 if N/A)	Angle of 36th harmonic referenced to fundamental Voltage A-N (4-wire) or Voltage A-B (3-wire).
Base + 74	H37 Magnitude	% D,E A,B	.01 Volts/Scale Amps/Scale	0 – 10000 0 – 32,767 0 – 32,767	Magnitude of harmonic expressed as a percentage of the reference value, or as an absolute value.
Base + 75	H37 Angle	—	0.1 °	0 – 3,599 (-32,678 if N/A)	Angle of 37th harmonic referenced to fundamental Voltage A-N (4-wire) or Voltage A-B (3-wire).
Base + 76	H38 Magnitude	% D,E A,B	.01 Volts/Scale Amps/Scale	0 – 10000 0 – 32,767 0 – 32,767	Magnitude of harmonic expressed as a percentage of the reference value, or as an absolute value.
Base + 77	H38 Angle	—	0.1 °	0 – 3,599 (-32,678 if N/A)	Angle of 38th harmonic referenced to fundamental Voltage A-N (4-wire) or Voltage A-B (3-wire).
Base + 78	H39 Magnitude	% D,E A,B	.01 Volts/Scale Amps/Scale	0 – 10000 0 – 32,767 0 – 32,767	Magnitude of harmonic expressed as a percentage of the reference value, or as an absolute value.

# Power Meter Register List

## Register List

**Table A-6: Spectral Components**

Reg	Name	Scale	Units	Range	Notes
Base + 79	H39 Angle	—	0.1 °	0 – 3,599 (-32,678 if N/A)	Angle of 39th harmonic referenced to fundamental Voltage A-N (4-wire) or Voltage A-B (3-wire).
Base + 80	H40 Magnitude	% D,E A,B	.01 Volts/Scale Amps/Scale	0 – 10000 0 – 32,767 0 – 32,767	Magnitude of harmonic expressed as a percentage of the reference value, or as an absolute value.
Base + 81	H40 Angle	—	0.1 °	0 – 3,599 (-32,678 if N/A)	Angle of 40th harmonic referenced to fundamental Voltage A-N (4-wire) or Voltage A-B (3-wire).
Base + 82	H41 Magnitude	% D,E A,B	.01 Volts/Scale Amps/Scale	0 – 10000 0 – 32,767 0 – 32,767	Magnitude of harmonic expressed as a percentage of the reference value, or as an absolute value.
Base + 83	H41 Angle	—	0.1 °	0 – 3,599 (-32,678 if N/A)	Angle of 41st harmonic referenced to fundamental Voltage A-N (4-wire) or Voltage A-B (3-wire).
Base + 84	H42 Magnitude	% D,E A,B	.01 Volts/Scale Amps/Scale	0 – 10000 0 – 32,767 0 – 32,767	Magnitude of harmonic expressed as a percentage of the reference value, or as an absolute value.
Base + 85	H42 Angle	—	0.1 °	0 – 3,599 (-32,678 if N/A)	Angle of 42nd harmonic referenced to fundamental Voltage A-N (4-wire) or Voltage A-B (3-wire).
Base + 86	H43 Magnitude	% D,E A,B	.01 Volts/Scale Amps/Scale	0 – 10000 0 – 32,767 0 – 32,767	Magnitude of harmonic expressed as a percentage of the reference value, or as an absolute value.
Base + 87	H43 Angle	—	0.1 °	0 – 3,599 (-32,678 if N/A)	Angle of 43rd harmonic referenced to fundamental Voltage A-N (4-wire) or Voltage A-B (3-wire).
Base + 88	H44 Magnitude	% D,E A,B	.01 Volts/Scale Amps/Scale	0 – 10000 0 – 32,767 0 – 32,767	Magnitude of harmonic expressed as a percentage of the reference value, or as an absolute value.
Base + 89	H44 Angle	—	0.1 °	0 – 3,599 (-32,678 if N/A)	Angle of 44th harmonic referenced to fundamental Voltage A-N (4-wire) or Voltage A-B (3-wire).
Base + 90	H45 Magnitude	% D,E A,B	.01 Volts/Scale Amps/Scale	0 – 10000 0 – 32,767 0 – 32,767	Magnitude of harmonic expressed as a percentage of the reference value, or as an absolute value.
Base + 91	H45 Angle	—	0.1 °	0 – 3,599 (-32,678 if N/A)	Angle of 45th harmonic referenced to fundamental Voltage A-N (4-wire) or Voltage A-B (3-wire).

# Power Meter Register List

## Register List

**Table A-6: Spectral Components**

Reg	Name	Scale	Units	Range	Notes
Base + 92	H46 Magnitude	% D,E A,B	.01 Volts/Scale Amps/Scale	0 – 10000 0 – 32,767 0 – 32,767	Magnitude of harmonic expressed as a percentage of the reference value, or as an absolute value.
Base + 93	H46 Angle	—	0.1 °	0 – 3,599 (-32,678 if N/A)	Angle of 46th harmonic referenced to fundamental Voltage A-N (4-wire) or Voltage A-B (3-wire).
Base + 94	H47 Magnitude	% D,E A,B	.01 Volts/Scale Amps/Scale	0 – 10000 0 – 32,767 0 – 32,767	Magnitude of harmonic expressed as a percentage of the reference value, or as an absolute value.
Base + 95	H47 Angle	—	0.1 °	0 – 3,599 (-32,678 if N/A)	Angle of 47th harmonic referenced to fundamental Voltage A-N (4-wire) or Voltage A-B (3-wire).
Base + 96	H48 Magnitude	% D,E A,B	.01 Volts/Scale Amps/Scale	0 – 10000 0 – 32,767 0 – 32,767	Magnitude of harmonic expressed as a percentage of the reference value, or as an absolute value.
Base + 97	H48 Angle	—	0.1 °	0 – 3,599 (-32,678 if N/A)	Angle of 48th harmonic referenced to fundamental Voltage A-N (4-wire) or Voltage A-B (3-wire).
Base + 98	H49 Magnitude	% D,E A,B	.01 Volts/Scale Amps/Scale	0 – 10000 0 – 32,767 0 – 32,767	Magnitude of harmonic expressed as a percentage of the reference value, or as an absolute value.
Base + 99	H49 Angle	—	0.1 °	0 – 3,599 (-32,678 if N/A)	Angle of 49th harmonic referenced to fundamental Voltage A-N (4-wire) or Voltage A-B (3-wire).
Base + 100	H50 Magnitude	% D,E A,B	.01 Volts/Scale Amps/Scale	0 – 10000 0 – 32,767 0 – 32,767	Magnitude of harmonic expressed as a percentage of the reference value, or as an absolute value.
Base + 101	H50 Angle	—	0.1 °	0 – 3,599 (-32,678 if N/A)	Angle of 50th harmonic referenced to fundamental Voltage A-N (4-wire) or Voltage A-B (3-wire).
Base + 102	H51 Magnitude	% D,E A,B	.01 Volts/Scale Amps/Scale	0 – 10000 0 – 32,767 0 – 32,767	Magnitude of harmonic expressed as a percentage of the reference value, or as an absolute value.
Base + 103	H51 Angle	—	0.1 °	0 – 3,599 (-32,678 if N/A)	Angle of 51st harmonic referenced to fundamental Voltage A-N (4-wire) or Voltage A-B (3-wire).
Base + 104	H52 Magnitude	% D,E A,B	.01 Volts/Scale Amps/Scale	0 – 10000 0 – 32,767 0 – 32,767	Magnitude of harmonic expressed as a percentage of the reference value, or as an absolute value.

# Power Meter Register List

## Register List

**Table A-6: Spectral Components**

Reg	Name	Scale	Units	Range	Notes
Base + 105	H52 Angle	—	0.1 °	0 – 3,599 (-32,678 if N/A)	Angle of 52nd harmonic referenced to fundamental Voltage A-N (4-wire) or Voltage A-B (3-wire).
Base + 106	H53 Magnitude	% D,E A,B	.01 Volts/Scale Amps/Scale	0 – 10000 0 – 32,767 0 – 32,767	Magnitude of harmonic expressed as a percentage of the reference value, or as an absolute value.
Base + 107	H53 Angle	—	0.1 °	0 – 3,599 (-32,678 if N/A)	Angle of 53rd harmonic referenced to fundamental Voltage A-N (4-wire) or Voltage A-B (3-wire).
Base + 108	H54 Magnitude	% D,E A,B	.01 Volts/Scale Amps/Scale	0 – 10000 0 – 32,767 0 – 32,767	Magnitude of harmonic expressed as a percentage of the reference value, or as an absolute value.
Base + 109	H54 Angle	—	0.1 °	0 – 3,599 (-32,678 if N/A)	Angle of 54th harmonic referenced to fundamental Voltage A-N (4-wire) or Voltage A-B (3-wire).
Base + 110	H55 Magnitude	% D,E A,B	.01 Volts/Scale Amps/Scale	0 – 10000 0 – 32,767 0 – 32,767	Magnitude of harmonic expressed as a percentage of the reference value, or as an absolute value.
Base + 111	H55 Angle	—	0.1 °	0 – 3,599 (-32,678 if N/A)	Angle of 55th harmonic referenced to fundamental Voltage A-N (4-wire) or Voltage A-B (3-wire).
Base + 112	H56 Magnitude	% D,E A,B	.01 Volts/Scale Amps/Scale	0 – 10000 0 – 32,767 0 – 32,767	Magnitude of harmonic expressed as a percentage of the reference value, or as an absolute value.
Base + 113	H56 Angle	—	0.1 °	0 – 3,599 (-32,678 if N/A)	Angle of 56th harmonic referenced to fundamental Voltage A-N (4-wire) or Voltage A-B (3-wire).
Base + 114	H57 Magnitude	% D,E A,B	.01 Volts/Scale Amps/Scale	0 – 10000 0 – 32,767 0 – 32,767	Magnitude of harmonic expressed as a percentage of the reference value, or as an absolute value.
Base + 115	H57 Angle	—	0.1 °	0 – 3,599 (-32,678 if N/A)	Angle of 57th harmonic referenced to fundamental Voltage A-N (4-wire) or Voltage A-B (3-wire).
Base + 116	H58 Magnitude	% D,E A,B	.01 Volts/Scale Amps/Scale	0 – 10000 0 – 32,767 0 – 32,767	Magnitude of harmonic expressed as a percentage of the reference value, or as an absolute value.
Base + 117	H58 Angle	—	0.1 °	0 – 3,599 (-32,678 if N/A)	Angle of 58th harmonic referenced to fundamental Voltage A-N (4-wire) or Voltage A-B (3-wire).



# Power Meter Register List

## Register List

**Table A-6: Spectral Components**

Reg	Name	Scale	Units	Range	Notes
Base + 118	H59 Magnitude	% D,E A,B	.01 Volts/Scale Amps/Scale	0 – 10000 0 – 32,767 0 – 32,767	Magnitude of harmonic expressed as a percentage of the reference value, or as an absolute value.
Base + 119	H59 Angle	—	0.1 °	0 – 3,599 (-32,678 if N/A)	Angle of 59th harmonic referenced to fundamental Voltage A-N (4-wire) or Voltage A-B (3-wire).
Base + 120	H60 Magnitude	% D,E A,B	.01 Volts/Scale Amps/Scale	0 – 10000 0 – 32,767 0 – 32,767	Magnitude of harmonic expressed as a percentage of the reference value, or as an absolute value.
Base + 121	H60 Angle	—	0.1 °	0 – 3,599 (-32,678 if N/A)	Angle of 60th harmonic referenced to fundamental Voltage A-N (4-wire) or Voltage A-B (3-wire).
Base + 122	H61 Magnitude	% D,E A,B	.01 Volts/Scale Amps/Scale	0 – 10000 0 – 32,767 0 – 32,767	Magnitude of harmonic expressed as a percentage of the reference value, or as an absolute value.
Base + 123	H61 Angle	—	0.1 °	0 – 3,599 (-32,678 if N/A)	Angle of 61st harmonic referenced to fundamental Voltage A-N (4-wire) or Voltage A-B (3-wire).
Base + 124	H62 Magnitude	% D,E A,B	.01 Volts/Scale Amps/Scale	0 – 10000 0 – 32,767 0 – 32,767	Magnitude of harmonic expressed as a percentage of the reference value, or as an absolute value.
Base + 125	H62 Angle	—	0.1 °	0 – 3,599 (-32,678 if N/A)	Angle of 62nd harmonic referenced to fundamental Voltage A-N (4-wire) or Voltage A-B (3-wire).
Base + 126	H63 Magnitude	% D,E A,B	.01 Volts/Scale Amps/Scale	0 – 10000 0 – 32,767 0 – 32,767	Magnitude of harmonic expressed as a percentage of the reference value, or as an absolute value.
Base + 127	H63 Angle	—	0.1 °	0 – 3,599 (-32,678 if N/A)	Angle of 63rd harmonic referenced to fundamental Voltage A-N (4-wire) or Voltage A-B (3-wire).

## Power Meter Register List

### Register List

---

# Using the Command Interface

## Overview of the Command Interface

### Overview of the Command Interface

The power meter provides a command interface, which you can use to issue commands that perform various operations such as controlling relays.

Table B–2 on page 157 lists the available commands. The command interface is located in memory at registers 8000–8149. Table B–1 lists the definitions for the registers.

**Table B–1: Location of the command interface**

Register	Description
8000	This is the register where you write the commands.
8001–8015	These are the registers where you write the parameters for a command. Commands can have up to 15 parameters associated with them.
8017	Command pointer. This register holds the register number where the last command is stored.
8018	Results pointer. This register holds the register number where the last command is stored.
8019	I/O data pointer. Use this register to point to data buffer registers where you can send additional data or return data.
8020–8149	These registers are for you (the user) to write information. Depending on which pointer places the information in the register, the register can contain status (from pointer 8017), results (from pointer 8018), or data (from pointer 8019). The registers will contain information such as whether the function is enabled or disabled, set to fill and hold, start and stop times, logging intervals, and so forth.  By default, return data will start at 8020 unless you specify otherwise.

When registers 8017–8019 are set to zero, no values are returned. When any or all of these registers contain a value, the value in the register “points” to a target register, which contains the status, error code, or I/O data (depending on the command) when the command is executed. Figure B–1 shows how these registers work.

*NOTE: You determine the register location where results will be written. Therefore, take care when assigning register values in the pointer registers;*

# Using the Command Interface

## Overview of the Command Interface

*values may be corrupted when two commands use the same register.*

**Figure B-1: Command interface pointer registers**

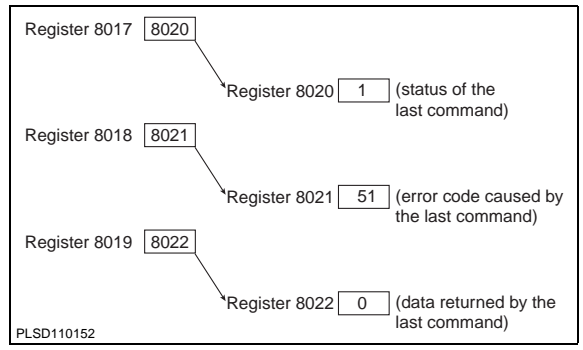

### Issuing Commands

To issue commands using the command interface, follow these general steps:

1. Write the related parameter(s) to the command parameter registers 8001–15.
2. Write the command code to command interface register 8000.

If no parameters are associated with the command, then you need only to write the command code to register 8000. Table B-2 lists the command codes that can be written to the command interface into register 8000. Some commands have an associated registers where you write parameters for that command. For example, when you write the parameter 9999 to register 8001 and issue command code 3351, all relays will be energized if they are set up for external control.

# Using the Command Interface

## Overview of the Command Interface

Table B-2: Command Codes

Command Code	Command Parameter Register	Parameters	Description
1110	None	None	Causes soft reset of the unit (re-initializes the power meter).
1210	None	None	Clears the communications counters.
1310	8001 8002 8003 8004 8005 8006	Month Day Year Hour Minute Second	Sets the system date and time. Values for the registers are: Month (1–12) Day (1–31) Year (4-digit, for example 2000) Hour (Military time, for example 14 = 2:00pm) Minute (1–59) Second (1–59)
<b>Relay Outputs</b>			
3310	8001	Relay Output Number ①	Configures relay for external control.
3311	8001	Relay Output Number ①	Configures relay for internal control.
3320	8001	Relay Output Number ①	De-energizes designated relay.
3321	8001	Relay Output Number ①	Energizes designated relay.
3330	8001	Relay Output Number ①	Releases specified relay from latched condition.
3340	8001	Relay Output Number ①	Releases specified relay from override control.
3341	8001	Relay Output Number ①	Places specified relay under override control.
3350	8001	9999	De-energizes all relays.
3351	8001	9999	Energizes all relays.
3361	8001	Relay Output Number ①	Resets operation counter for specified relay.
3362	8001	Relay Output Number ①	Resets the turn-on time for specified relay.
3363	8001	None	Resets the operation counter for all relays.
3364	8001	None	Resets the turn-on time for all relays.
3365	8001	Input Number ①	Resets the operation counter for specified input.
3366	8001	Input Number ①	Resets turn-on time for specified input.
3367	8001	None	Resets the operation counter for all inputs.
3368	8001	None	Resets turn-on time for all inputs.
3369	8001	None	Resets all counters and timers for all I/Os.
<b>Resets</b>			
1522	None	None	Resets the alarm history log.

① You must write to register 8001 the number that identifies which output you would like to use. To determine the identifying number, refer to "I/O Point Numbers" on page 159 for instructions.

② Data buffer location (register 8019) is the pointer to the first register where data will be stored. By default, return data begins at register 8020, although you can use any of the registers from 8020–8149. *Take care when assigning pointers. Values may be corrupted if two commands are using the same register.*

## Using the Command Interface

### Overview of the Command Interface

**Table B-2: Command Codes**

Command Code	Command Parameter Register	Parameters	Description
4110	None	0 = Present and previous months 1 = Present month 2 = Previous month	Resets min/max.
5110	None	None	Resets all demand registers.
5111	None	None	Resets current demand.
5113	None	None	Resets power demand.
5114	None	None	Resets input demand.
5115	None	None	Resets generic demand for first group of 10 quantities.
5210	None	None	Resets all min/max demand.
5211	None	None	Resets current min/max demand.
5213	None	None	Resets power min/max demand.
5214	None	None	Resets input min/max demand.
5215	None	None	Resets generic 1 min/max demand.
5910	8001	Bitmap	Start new demand interval. Bit 0 = Power Demand 1 = Current Demand 2 = Input Metering Demand 3 = Generic Demand Profile
6209	8019	I/O Data Pointer ②	Preset Accumulated Energies Requires the IO Data Pointer to point to registers where energy preset values are entered. All Accumulated energy values must be entered in the order in which they occur in registers 1700 to 1727.
6210	None	None	Clears all energies.
6211	None	None	Clears all accumulated energy values.
6212	None	None	Clears conditional energy values.
6213	None	None	Clears incremental energy values.
6214	None	None	Clears input metering accumulation.

① You must write to register 8001 the number that identifies which output you would like to use. To determine the identifying number, refer to "I/O Point Numbers" on page 159 for instructions.

② Data buffer location (register 8019) is the pointer to the first register where data will be stored. By default, return data begins at register 8020, although you can use any of the registers from 8020–8149. *Take care when assigning pointers. Values may be corrupted if two commands are using the same register.*

# Using the Command Interface

## Overview of the Command Interface

**Table B-2: Command Codes**

Command Code	Command Parameter Register	Parameters	Description
6215	None	1 = IEEE 2 = IEC	Resets the following parameters to IEEE or IEC defaults: 1. Phase labels 2. Menu labels 3. Harmonic units 4. PF sign 5. THD denominator 6. Date Format
6320	None	None	Disables conditional energy accumulation.
6321	None	None	Enables conditional energy accumulation.
6910	None	None	Starts a new incremental energy interval.
<b>Files</b>			
7510	8001	1–3	Triggers data log entry. Bitmap where Bit 0 = Data Log 1, Bit 1 = Data Log 2, Bit 2 = Data Log 3, etc.
7511	8001	File Number	Triggers single data log entry.
<b>Setup</b>			
9020	None	None	Enter into setup mode.
9021	8001	1 = Save 2 = Do not save	Exit setup mode and save all changes.
<p>① You must write to register 8001 the number that identifies which output you would like to use. To determine the identifying number, refer to "I/O Point Numbers" on page 159 for instructions.</p> <p>② Data buffer location (register 8019) is the pointer to the first register where data will be stored. By default, return data begins at register 8020, although you can use any of the registers from 8020–8149. <i>Take care when assigning pointers. Values may be corrupted if two commands are using the same register.</i></p>			

### I/O Point Numbers

All inputs and outputs of the power meter have a reference number and a label that correspond to the position of that particular input or output.

- The reference number is used to manually control the input or output with the command interface.
- The label is the default identifier that identifies that same input or output. The label appears on the display, in SMS, and on the option card.

## Using the Command Interface

### Operating Outputs from the Command Interface

---

#### Operating Outputs from the Command Interface

To operate an output from the command interface, first identify the relay using the *I/O point number*. Then, set the output to external control. For example, to energize output 1, write the commands as follows:

1. Write number 1 to register 8001.
2. Write command code 3310 to register 8000 to set the relay to external control.
3. Write command code 3321 to register 8000.

If you look in the “Relay Outputs” section of Table B–2 on page 157, you’ll see that command code 3310 sets the relay to external control and command code 3321 is listed as the command used to energize a relay. Command codes 3310–3381 are for use with inputs and outputs.

#### Using the Command Interface to Change Configuration Registers

You can also use the command interface to change values in selected metering-related registers, such as setting the time of day of the clock or resetting generic demand.

Two commands, 9020 and 9021, work together as part of the command interface procedure when you use it to change power meter configuration. You must first issue command 9020 to enter into setup mode, change the register, and then issue 9021 to save your changes and exit setup mode.

Only one setup session is allowed at a time. While in this mode, if the power meter detects more than two minutes of inactivity, that is, if you do not write any register values or press any buttons on the display, the power meter will timeout and restore the original configuration values. All changes will be lost. Also, if



## Using the Command Interface

### Conditional Energy

---

the power meter loses power or communications while in setup mode, your changes will be lost.

The general procedure for changing configuration registers using the command interface is as follows:

1. Issue command 9020 in register 8000 to enter into the setup mode.
2. Make changes to the appropriate register by writing the new value to that register. Perform register writes to all registers that you want to change. For instructions on reading and writing registers, see “View the Meter Information” on page 22 in **Chapter 3—Operation**.
3. To save the changes, write the value 1 to register 8001.

*NOTE: Writing any other value except 1 to register 8001 lets you exit setup mode without saving your changes.*

4. Issue command 9021 in register 8000 to initiate the save and reset the power meter.

For example, the procedure to change the demand interval for current is as follows:

1. Issue command code 9020 in register 8000.
2. Write the new demand interval to register 1801.
3. Write 1 to register 8001.
4. Issue command code 9021 in register 8000.

See **Appendix A—Power Meter Register List** on page 85 for those registers that require you to enter setup mode to make changes to the registers.

## Conditional Energy

Power meter registers 1728–1744 are conditional energy registers.

## Using the Command Interface

### Conditional Energy

---

Conditional energy can be controlled in one of two ways:

- Over the communications link, by writing commands to the power meter's command interface, or
- By a digital input—for example, conditional energy accumulates when the assigned digital input is on, but does not accumulate when the digital input is off.

The following procedures tell how to set up conditional energy for command interface control, and for digital input control. The procedures refer to register numbers and command codes. For a listing of power meter registers, see **Appendix A—Register List** on page 87. For a listing of command codes, see Table B-2 on page 157 in this chapter.

#### Command Interface Control

**Set Control**—To *set control* of conditional energy to the command interface:

1. Write command code 9020 to register 8000.
2. In register 3227, set bit 6 to 1 (preserve other bits that are ON).
3. Write 1 to register 8001.
4. Write command code 9021 to register 8000.

**Start**— To *start* conditional energy accumulation, write command code 6321 to register 8000.

**Verify Setup**—To *verify proper setup*, read register 1794. The register should read 1, indicating conditional energy accumulation is ON.

**Stop**—To *stop* conditional energy accumulation, write command code 6320 to register 8000.

## Using the Command Interface

### Conditional Energy

---

**Clear**—To *clear* all conditional energy registers (1728-1747), write command code 6212 to register 8000.

#### Digital Input Control

**Set Control**—To configure conditional energy for digital input control:

1. Write command code 9020 to register 8000.
2. In register 3227, set bit 6 to 0 (preserve other bits that are ON).
3. Configure the digital input that will drive conditional energy accumulation. For the appropriate digital input, write 3 to the *Base +9* register. See the digital input templates in Table A-3 on page 87 in **Appendix A—Power Meter Register List** on page 85.
4. Write 1 to register 8001.
5. Write command code 9021 to register 8000.

**Clear**—To clear all conditional energy registers (1728-1747), write command code 6212 to register 8000.

**Verify Setup**—To *verify proper setup*, read register 1794. The register should read 0 when the digital input is off, indicating that conditional energy accumulation is off. The register should read 1 when conditional energy accumulation is on.

## Using the Command Interface

### Incremental Energy

---

#### Incremental Energy

The power meter's incremental energy feature allows you to define a start time, end time, and time interval for incremental energy accumulation. At the end of each incremental energy period, the following information is available:

- Wh IN during the last completed interval (reg. 1748–1750)
- VARh IN during the last completed interval (reg. 1751–1753)
- Wh OUT during the last completed interval (reg. 1754–1756)
- VARh OUT during the last completed interval (reg. 1757–1759)
- VAh during the last completed interval (reg. 1760–1762)
- Date/time of the last completed interval (reg. 1763–1765)
- Peak kW demand during the last completed interval (reg. 1940)
- Date/Time of Peak kW during the last interval (reg. 1941–1943)
- Peak kVAR demand during the last completed interval (reg. 1945)
- Date/Time of Peak kVAR during the last interval (reg. 1946–1948)
- Peak kVA demand during the last completed interval (reg. 1950)
- Date/Time of Peak kVA during the last interval (reg. 1951–1953)

The power meter can log the incremental energy data listed above. This logged data provides all the information needed to analyze energy and power usage against present or future utility rates. The information is especially useful for comparing different time-of-use rate structures.

## Using the Command Interface

### Incremental Energy

---

When using the incremental energy feature, keep the following points in mind:

- Peak demands help minimize the size of the data log in cases of sliding or rolling demand. Shorter incremental energy periods make it easier to reconstruct a load profile analysis.
- Since the incremental energy registers are synchronized to the power meter clock, it is possible to log this data from multiple circuits and perform accurate totalizing.

### Using Incremental Energy

Incremental energy accumulation begins at the specified start time and ends at the specified end time. When the start time arrives, a new incremental energy period begins. The start and end time are specified in minutes from midnight. For example:

Interval: 420 minutes (7 hours)

Start time: 480 minutes (8:00 a.m.)

End time = 1440 minutes (12:00 p.m.)

The first incremental energy calculation will be from 8:00 a.m. to 3:00 p.m. (7 hours) as illustrated in Figure B-2 on page 166. The next interval will be from 3:00 p.m. to 10:00 p.m., and the third interval will be from 10 p.m. to 12:00 p.m. because 12:00 p.m. is the specified end time. A new interval will begin on the next day at 8:00 a.m. Incremental energy accumulation will continue in this manner until the configuration is changed or a new interval is started by a remote master.

# Using the Command Interface

## Incremental Energy

**Figure B-2: Incremental energy example**

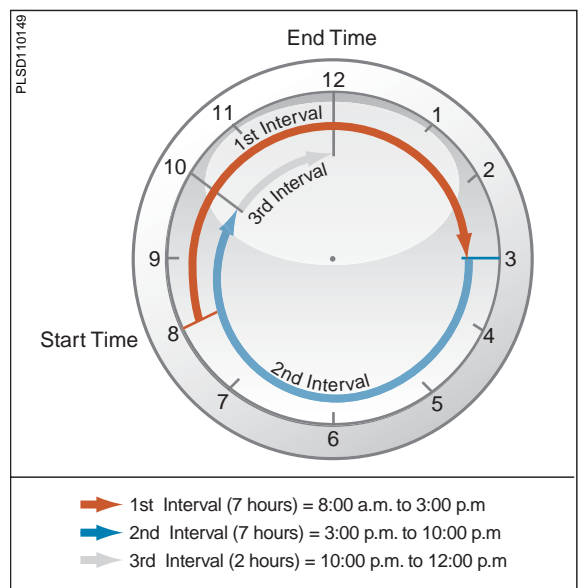

**Set up**—To set up incremental energy:

1. Write command code 9020 to register 8000.
2. In register 3230, write a start time (in minutes-from-midnight).
3. For example, 8:00 am is 480 minutes.
4. In register 3231, write an end time (in minutes-from-midnight).
5. Write the desired interval length, from 0–1440 minutes, to register 3229.
6. If incremental energy will be controlled from a remote master, such as a programmable controller, write 0 to the register.
7. Write 1 to register 8001.
8. Write command code 9021 to register 8000.

**Start**—To start a new incremental energy interval from a remote master, write command code 6910 to register 8000.

## Using the Command Interface

### Setting Up Individual Harmonic Calculations

#### Setting Up Individual Harmonic Calculations

The power meter can perform harmonic magnitude and angle calculations up to the 63rd harmonic magnitude for each metered value and for each residual value. The harmonic magnitude for current and voltage can be formatted as either a percentage of the fundamental (THD), as a percentage of the rms values (thd), or rms. The harmonic magnitude and angles are stored in a set of registers: 13,200–14,608. During the time that the power meter is refreshing harmonic data, the power meter posts a value of 0 in register 3246. When the set of harmonic registers is updated with new data, the power meter posts a value of 1 in register 3246. The power meter can be configured to hold the values in these registers for up to 60 metering update cycles once the data processing is complete.

The power meter has three operating modes for harmonic data processing: disabled, magnitude only, and magnitude and angles. Because of the extra processing time necessary to perform these calculations, the factory default operating mode is magnitudes only.

To configure the harmonic data processing, write to the registers described in Table B–3:

**Table B–3: Registers for Harmonic Calculations**

Reg No.	Value	Description
3240	0, 1, 2	Harmonic processing; 0 = disabled 1 = magnitudes only enabled 2 = magnitudes and angles enabled
3241	0, 1, 2	Harmonic magnitude formatting for voltage; 0 = % of fundamental (default) 1 = % of rms 2 = rms

# Using the Command Interface

## Changing Scale Factors

**Table B-3: Registers for Harmonic Calculations**

Reg No.	Value	Description
3242	0, 1, 2	Harmonic magnitude formatting for current; 0 = % of fundamental (default) 1 = % of rms 2 = rms
3243	10-60 seconds	This register shows the harmonics refresh interval (default is 30 seconds).
3244	0-60 seconds	This register shows the time remaining before the next harmonic data update.
3245	0,1	This register indicates whether harmonic data processing is complete: 0 = processing incomplete 1 = processing complete

### Changing Scale Factors

The power meter stores instantaneous metering data in 16-bit single registers. A value held in each register must be an integer between -32,767 and +32,767. Because some values for metered current, voltage, and power readings fall outside this range, the power meter uses multipliers, or scale factors. This enables the power meter to extend the range of metered values that it can record.

The power meter stores these multipliers as scale factors. A scale factor is the multiplier expressed as a power of 10. For example, a multiplier of 10 is represented as a scale factor of 1, since  $10^1=10$ ; a multiplier of 100 is represented as a scale factor of 2, since  $10^2=100$ .

You can change the default value of 1 to other values such as 10, 100, or 1,000. However, these scale factors are automatically selected when you set up the power meter, either from the display or by using SMS.

If the power meter displays “overflow” for any reading, change the scale factor to bring the reading back into



## Using the Command Interface

### Changing Scale Factors

---

a range that fits in the register. For example, because the register cannot store a number as large as 138,000, a 138 kV system requires a multiplier of 10. 138,000 is converted to 13,800 x 10. The power meter stores this value as 13,800 with a scale factor of 1 (because  $10^1=10$ ).

Scale factors are arranged in scale groups. The abbreviated register list in **Appendix A—Power Meter Register List** on page 85 shows the scale group associated with each metered value.

You can use the command interface to change scale factors on a group of metered values. However, be aware of these important points if you choose to change scale factors:

**NOTE:**

- We **strongly recommend** that you do not change the default scale factors, which are automatically selected by POWERLOGIC hardware and software.
- When using custom software to read power meter data over the communications link, you must account for these scale factors. To correctly read any metered value with a scale factor other than 0, multiply the register value read by the appropriate power of 10.
- As with any change to basic meter setup, when you change a scale factor, all min/max and peak demand values should be reset.

# Using the Command Interface

## Changing Scale Factors

---

# Index

---

- A**
  - accumulate energy
    - signed or unsigned more 39
  - address
    - device address 84
  - alarm backlight
    - setup 18
  - alarm levels
    - with different pickups and dropouts 57
  - alarm log
    - description 70
  - alarms
    - abbreviated names defined 65
    - alarm conditions 53, 64
    - alarm groups 53
    - alarm levels 56
    - alarm types 64, 65, 66
    - Boolean 53
    - creating data log entries 71
    - creating levels for multiple alarms 57
    - custom alarms 58
    - introduction to 53
    - priorities 56
    - scaling alarm setpoints 62, 63
    - setpoints 54
    - setup 16
    - types 59
- B**
  - baud rate 84
  - block interval demand method 31
  - Boolean alarms 53
    - logic gates 67
- C**
  - calculating
    - duration of an event 56
    - watthours per pulse 51
  - changing
    - scale factors 61
  - clock synchronized demand 34, 35
  - command interface
    - changing configuration registers 160
    - issuing commands 156
    - operating outputs 160
    - overview 155
    - registers for 155
    - scale factors 169
  - command synchronized demand 34
  - communications
    - problems with PC communication 84
    - setup 12
  - conditional energy
    - controlling from the command interface 162
    - register for 161
  - contacting technical support 81
  - controlling relays 45
  - correlation sequence number 56
  - CT
    - setup 14
  - custom
    - alarms 58
- D**
  - data log 70
    - clearing the logs 71
    - organizing log files 71
    - storage in power meter 79
  - date
    - setup 13
  - demand
    - current 35
    - generic 37
    - predicted 36
    - thermal 35
  - demand current calculation 35
  - demand power
    - calculation 31
  - demand power calculation methods 35
  - demand readings 30
    - demand current 35
    - demand power calculation methods 31
    - generic demand 37
    - peak demand 36
    - predicted demand 36
  - demand synch pulse method 44
  - diagnostics password 18
  - digital alarms 53
  - digital inputs 43
    - digital input alarms 53
    - operating modes 43
    - receiving a synch pulse 34
  - displacement power factor described 41
  - display
    - menu overview 10
    - operating 9
  - dropout and pickup setpoints 54
- E**
  - energy
    - conditional energy registers 162
    - energy readings 38, 40
      - reactive accumulated 40
    - energy reset password 18
  - event log
    - calculating duration of event 56
    - correlation sequence number 56
    - data storage 70
- F**
  - firmware 4
  - fixed block 31
- G**
  - generic demand calculation 37
  - getting technical support 81
- H**
  - harmonic
    - setting up individual calculations 167
    - values 42
  - health status 23
  - high priority alarms 56
  - Hi-Pot testing 79
- I**
  - I/O
    - position numbers 159
    - setup 17
  - incremental energy 164
    - interval 37
    - using with the command interface 165

# Index

- incremental energy interval
  - setup 20
- input
  - digital input 43
- input synchronized demand 34
- input/output
  - setup 17
- inputs
  - accepting pulse from another meter 34
  - digital input alarms 53
  - digital inputs operating modes 43
- issuing commands 156
- K**
- KY 49
  - calculating watt hours per pulse 51
- L**
- labels
  - for inputs and outputs 159
- language
  - setup 14
- lock resets
  - setup 21
- logic gates for Boolean alarms 67
- logs 69
  - alarm log 70
  - clearing data logs 71
  - data log file 70
  - organizing data log files 71
  - recorded maintenance data 74
- low priority alarms 56
- M**
- maintenance
  - maintenance icon 83
  - maintenance log 74
- medium priority alarms 56
- megger testing 79
- memory
  - power meter memory 79
- menu 10
- meter information 22
- metered values
  - demand readings 30
  - energy readings 38
  - real-time readings 25
- minimum/maximum reset password 18
- N**
- no priority alarms 56
- nonvolatile memory 79
- O**
- on-board logs 69
- operation 9
  - problems with the power meter 83
  - using the command interface 155
- overvoltage alarm type 59
- P**
- passwords
  - setup 18
- peak demand calculation 36
- phase loss
  - alarm type for current 60
  - alarm type for voltage 60
- phase reversal alarm type 61
- phase rotation
  - setup 19
- pickups and dropouts
  - scale factors 62
  - setpoints 54
- PLC
  - synchronizing demand with 34
- power analysis values 41, 42
- power factor 41
  - min/max conventions 27
  - storage of 85
- power meter
  - accessories 3
  - described 1
  - features 4
  - firmware 4
  - hardware 2
  - instrumentation summary 1
  - parts 3
  - setup 12
- predicted demand calculation 36
- problems
  - see troubleshooting 82
- protocols
  - register addressing convention 85
- PT
  - setup 15
- Q**
- quantities
  - used in alarm levels 57
- R**
- read registers 23
- readings
  - demand 30
- real-time readings 25
  - min/max values 26
- recording
  - data in logs 70
- register
  - addressing convention 85
  - power factor format 86
- registers
  - for conditional energy 161
  - read 23
  - using the command interface 160
  - write 23
- relay operating modes 45
  - absolute kVARh pulse 47
  - absolute kWh pulse 47
  - end of demand interval 47
  - kVAh pulse 48
  - kVAR out pulse 48
  - kVARh in pulse 48
  - kWh in pulse 48
  - kWh out pulse 48
  - latched 46
  - normal 46
  - timed 47
- relays
  - internal or external control of 45
  - operating using command interface 156
- resets
  - of peak demand values 36
  - values in generic demand profile 38
- reverse power alarm type 61

# Index

---

rolling block 31  
route statement 84

## S

scale factors 61  
    changing scale factors 169  
    scale groups 62  
    scaling alarm setpoints 63  
scale groups 62  
set up  
    custom alarms 58  
    individual harmonic calculations 167  
setup 12  
    alarm backlight 18  
    alarms 16  
    communications 12  
    CT 14  
    date 13  
    I/O 17  
    incremental energy interval 20  
    input/output 17  
    language 14  
    lock resets 21  
    passwords 18  
    phase rotation 19  
    PT 15  
    system type 15  
    THD calculation 20  
    time 13  
    VAR/PF convention 21  
setup password 18  
sliding block 31  
SMS  
    using SMS 4  
standard alarms 53  
steady-state harmonics 77  
synchronized demand  
    clock 34  
    command 34  
    input 34  
synchronizing  
    demand interval to internal clock 35  
    demand interval to multiple meters 34  
    to PLC command 34  
System Manager Software

    see SMS.  
system type  
    setup 15

## T

technical support 81  
testing  
    dielectric (hi-pot) test 79  
    megger test 79  
THD 77  
    setup 20  
    thd calculation method 41  
thermal demand method 35  
time  
    setup 13  
total harmonic distortion 41, 77  
types of alarms 66

## U

unbalance current alarm type 59  
unbalance voltage alarm type 60  
undervoltage alarm type 59

## V

VAR  
    sign conventions 29  
VAR/PF convention  
    setup 21  
viewing meter information 22

## W

watthours  
    calculating watthours per KYZ pulse 51  
waveform capture 77  
    initiating 77  
waveform captures  
    storage of waveforms 77  
wiring  
    troubleshooting 83  
write registers 23

# Index

---



Schneider Electric  
Power Management Operations  
295 Tech Park Drive, Suite 100  
LaVergne, TN 37086  
Tel: +1 (615) 287-3400  
www.powerlogic.com

**This product must be installed, connected, and used in compliance with prevailing standards and/or installation regulations.**

As standards, specifications, and designs change from time to time, please ask for confirmation of the information given in this publication.

**Ce produit doit être installé, raccordé et utilisé en respectant les normes et/ou les règlements d'installation en vigueur.**

En raison de l'évolution des normes et du matériel, les caractéristiques et cotes d'encombrement données ne nous engagent qu'après confirmation par nos services.

**Este producto deberá instalarse, conectarse y utilizarse en conformidad con las normas y/o los reglamentos de instalación vigentes.**

Debido a la evolución constante de las normas y del material, nos comprometemos únicamente con las características y cotas de volumen previa confirmación de nuestros servicios.

Publishing: Square D Company PMO

Production: Square D Company PMO