

Power Meter

Centrale de mesure
Central de medida
PM700

Instruction Bulletin
Manuel d'utilisation
Manual de instrucciones

Retain for future use.
À conserver pour une utilisation ultérieure
Consérvese para futuras consultas.



Schneider
 **Electric**

English	
Hazard Categories and Special Symbols	1
Table of Contents	3

Español	
Categorías de riesgos y símbolos especiales	61
Índice	63

Français	
Catégories de dangers et symboles spéciaux	123
Table des matières	125

HAZARD CATEGORIES AND SPECIAL SYMBOLS

Read these instructions carefully and look at the equipment to become familiar with the device before trying to install, operate, service, or maintain it. The following special messages may appear throughout this bulletin or on the equipment to warn of potential hazards or to call attention to information that clarifies or simplifies a procedure.



The addition of either symbol to a “Danger” or “Warning” safety label indicates that an electrical hazard exists which will result in personal injury if the instructions are not followed.



This is the safety alert symbol. It is used to alert you to potential personal injury hazards. Obey all safety messages that follow this symbol to avoid possible injury or death.

DANGER

DANGER indicates an immediately hazardous situation which, if not avoided, **will result in death or serious injury.**

WARNING

WARNING indicates a potentially hazardous situation which, if not avoided, **can result in death or serious injury.**

CAUTION

CAUTION indicates a potentially hazardous situation which, if not avoided, **can result in minor or moderate injury.**

CAUTION

CAUTION, used without the safety alert symbol, indicates a potentially hazardous situation which, if not avoided, **can result in property damage.**

NOTE: Provides additional information to clarify or simplify a procedure.

PLEASE NOTE

Electrical equipment should be installed, operated, serviced, and maintained only by qualified electrical personnel. No responsibility is assumed by Schneider Electric for any consequences arising out of the use of this manual.

CLASS B FCC STATEMENT

This equipment has been tested and found to comply with the limits for a Class B digital device, pursuant to part 15 of the FCC Rules. These limits are designed to provide reasonable protection against harmful interference when the equipment is operated in a commercial environment. This equipment generates, uses, and can radiate radio frequency energy and, if not installed and used in accordance with the instruction manual, may cause harmful interference to radio communications. Operation of this equipment in a residential area is likely to cause harmful interference in which case the user will be required to correct the interference at his own expense. This Class B digital apparatus complies with Canadian ICES-003.

INTRODUCTION	5
Box Contents	5
Identification	5
Power Meter Characteristics (PM700, PM700P, and PM710)	6
MODBUS RS485 (PM710)	7
Pulse Output (PM700P)	8
SAFETY PRECAUTIONS	9
Before You Begin	9
INSTALLATION	11
Dimensions	11
Mounting	12
Removing the Connectors	13
WIRING	15
Introduction	15
Supported System Types	16
Wiring Diagrams	17
Pulse Output Capabilities (PM700P)	23
Solid-state Pulse Output	23
COMMUNICATIONS (PM710)	25
Communications Capabilities (PM710)	25
Daisy-chaining Devices to the Power Meter	25
OPERATION	27
Operating the Display	27
How the Buttons Work	28
Menu Overview	28
POWER METER SETUP	31
Set Up the Power Meter	31
Set Up CTs	31
Set Up PTs	32
Set Up the System Frequency	32
Set Up the Meter System Type	33
Set Up Demand Current	33
Set Up PQS Demand	34
Set Up the Passwords	35
Set Up the Pulses (PM700P)	35
Set Up the Bargraph Scale	36

Set Up Communications (PM710)	36
Select the Operating Mode	37
Power Meter Diagnostics	37
View the Meter Information	37
Check the Health Status	38
Reset the Power Meter	38
Restore Power Meter Default Settings	38
MAINTENANCE AND TROUBLESHOOTING	39
Introduction	39
Getting Technical Support	39
Troubleshooting	39
SPECIFICATIONS	41
Power Meter Specifications	41
GLOSSARY	45
Glossary	45
Abbreviations and Symbols	47
REGISTER LIST	51
Register List	51
Supported MODBUS Commands	58
INDEX	59

Box Contents

- A. One (1) power meter
- B. Two (2) retainer clips
- C. One (1) installation and user manual
- D. PM710 only: One (1) RS-485 Terminator (MCT2W)

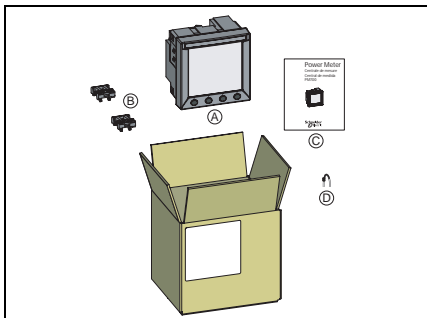

Identification

On the device:

- A. Control power
- B. Voltage inputs
- C. Current inputs
- D. kWh/kVARH pulse output (PM700P) or RS-485 (PM710)

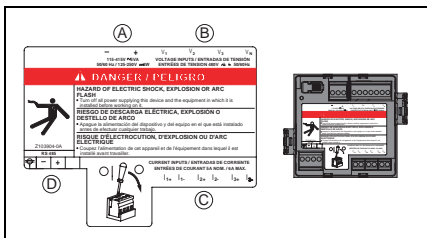

Power Meter Characteristics (PM700, PM700P, and PM710)

Instantaneous rms Values	
Current	Per phase, neutral, average of 3 phases
Voltage	Per phase, average of 3 phases
Frequency	45 to 65 Hz
Active power	Total and per phase
Reactive power	Total and per phase
Apparent power	Total and per phase
Power factor	Total (absolute) 0.000 to 1
Energy Values	
Active energy (total)	0 to 1.84×10^{18} Wh
Reactive energy (total)	0 to 1.84×10^{18} Wh
Apparent energy (total)	0 to 1.84×10^{18} Wh
Operating times	Up to 32,767 hours and 59 minutes
Demand Values	
Current	Per phase (Thermal)
Active, reactive, apparent power	Total (sliding block, rolling block, or block)
Maximum Demand Values	
Maximum current	Phase
Maximum active power	Total
Maximum reactive power	Total
Maximum apparent power	Total
Power-quality Values	
Total harmonic distortion (THD)	Current and voltage (L-L and L-N)
Reset	
Maximum demand current and power	Password protected
Energy values and operating time	Password protected
Minimum and maximum values	Password protected
Menu Modes	
IEC and IEEE	Display

Minimum and Maximum Values	
Total real power	
Total apparent power	
Total reactive power	
Total PF (power factor)	
Current per phase	
Voltage (L-L and L-N)	
THD current	
THD voltage (L-L and L-N)	
Local or Remote Setup (PM710 only)	
Type of distribution system	3-phase 3- or 4-wire with 1, 2, or 3 CTs, two- or single-phase
Rating of current transformers	Primary 5 to 32,767 A Secondary 5 or 1 A
Voltage	Primary 3,276,700 V max Secondary 100, 110, 115, 120
Calculation interval for demand currents	1 to 60 minutes
Calculation interval for demand power	1 to 60 minutes

MODBUS RS485 (PM710)

Functions	
RS485 link	2-wire
Communication protocol	MODBUS RTU
Settings	
Communication address	1 to 247
Baud rate (communication speed)	2400 to 19200 baud
Parity	none, even, odd

Pulse Output (PM700P)

Pulse Output	
Active Energy	Solid state relay
Reactive Energy	Solid state relay

Before You Begin

This chapter contains important safety precautions that must be followed before attempting to install, service, or maintain electrical equipment. Carefully READ and FOLLOW the safety precautions outlined below BEFORE working with the power meter.

DANGER

HAZARD OF ELECTRIC SHOCK, EXPLOSION, OR ARC FLASH

- Only qualified electrical workers should install this equipment. Such work should be performed only after reading this entire set of instructions.
- NEVER work alone.
- Before performing visual inspections, tests, or maintenance on this equipment, disconnect all sources of electric power. Assume that all circuits are live until they have been completely de-energized, tested, and tagged. Pay particular attention to the design of the power system. Consider all sources of power, including the possibility of backfeeding.
- Turn off all power supplying the power meter and the equipment in which it is installed before working on it.
- Always use a properly rated voltage sensing device to confirm that all power is off.
- Apply appropriate personal protective equipment (PPE) and follow safe electrical work practices. In the USA, see NFPA 70E.
- Before closing all covers and doors, carefully inspect the work area for tools and objects that may have been left inside the equipment.
- Use caution while removing or installing panels so that they do not extend into the energized bus; avoid handling the panels, which could cause personal injury.
- The successful operation of this equipment depends upon proper handling, installation, and operation. Neglecting fundamental installation requirements may lead to personal injury as well as damage to electrical equipment or other property.
- NEVER bypass external fusing.
- NEVER short the secondary of a PT.
- NEVER open circuit a CT; use the shorting block to short circuit the leads of the CT before removing the connection from the power meter.
- Before performing Dielectric (Hi-Pot) or Megger testing on any equipment in which the power meter is installed, disconnect all input and output wires to the power meter. High voltage testing may damage electronic components contained in the power meter.
- The power meter should be installed in a suitable electrical and fire enclosure.

Failure to follow this instruction will result in death or serious injury

Dimensions

Figure 3-1: Power Meter dimensions

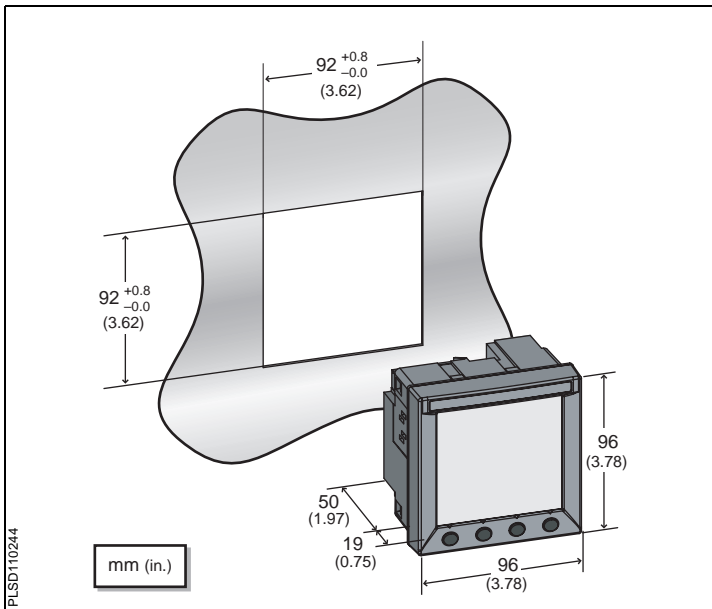

Mounting

1. Insert the power meter through the 92 mm x 92 mm (3.62 in. x 3.62 in.) cut-out (see Figure 3-1 on page 11).
2. Attach the two retainer clips to the power meter using the retainer slots at position A or position B.

There are two sets of retainer slots on the left, right, top and bottom of the power meter. The first set is for installation locations thinner than 3 mm (1/8 in.). The second set is for installation locations 3 to 6 mm (1/8 in. to 1/4 in.).

NOTE: For use on a flat surface of a protective enclosure (for example, in the USA: NEMA Type 1 rated enclosure or better).

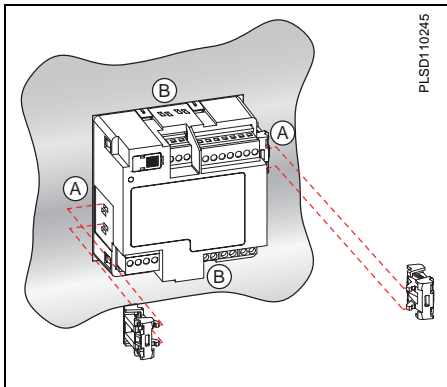

Removing the Connectors

1. Insert the flat end of a screwdriver into the groove between the power meter and the connector, as shown in the image.
2. Pull down the screwdriver to remove the connector.

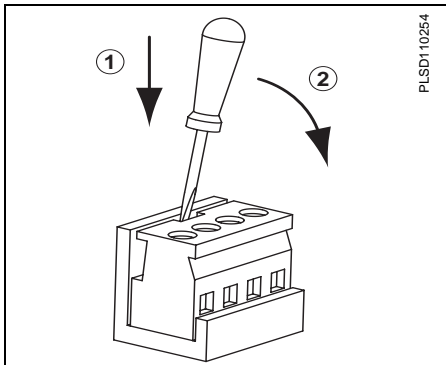

PLSD110254







Introduction

This chapter explains how to make the wiring connections for the power meter.

NOTE: Voltage inputs and control power for distribution systems up to 277 V L-N and 480 V L-L complies with metering category III. Also, terminal wiring should have a minimum temperature rating of 80°C.

The following symbols are used in the diagrams:

Table 4–1: Wiring Diagram Symbols

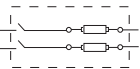
Symbol	Description
	Voltage disconnect switch
	Fuse
	Earth ground
	Current transformer
	Shorting block
	Potential transformer
	Protection containing a voltage disconnect switch with a fuse or disconnect circuit breaker (the protection device must be rated for the available short-circuit current at the connection point).

Supported System Types

Table 4-2: Voltages Less Than or Equal to 277 Vac L-N/480 Vac L-L, Direct Connect No PTs

Single-Phase Wiring (supported in a future firmware release)								
Number of Wires	CTs		Voltage Connections			Meter Configuration		Figure Number
	Qty.	ID	Qty.	ID	Type	System Type	PT Primary Scale	
2	1	I1	2	V1, Vn	L-N	10	No PT	4-1
2	1	I1	2	V1, V2	L-L	11	No PT	4-2
3	2	I1, I2	3	V1, V2, Vn	L-L with N	12	No PT	4-3
Three-Phase Wiring *								
3	2	I1, I3	3	V1, V2, V3	Delta	30	No PT	4-4
	3	I1, I2, I3	3	V1, V2, V3	Delta	31	No PT	4-5
3	1	I1	3	V1, V2, V3	Delta (Balanced)	32	No PT	4-15
4	3	I1, I2, I3	3	V1, V2, V3, Vn	4-wire Delta	40	No PT	4-6
4	3	I1, I2, I3	3	V1, V2, V3, Vn	Wye	40	No PT	4-6
4	1	I1	3	V1, V2, V3, Vn	Wye (Balanced)	44	No PT	4-14

Table 4-3: Voltages Greater Than 277 Vac L-N/480 Vac L-L

Three-Phase Wiring *								
Number of Wires	CTs		Voltage Connections			Meter Configuration		Figure Number
	Qty.	ID	Qty.	ID	Type	System Type	PT Primary Scale	
3	2	I1, I3	2	V1, V3 (V2 to Ground)	Delta	30	Based on voltage	4-7
	3	I1, I2, I3	2	V1, V3 (V2 to Ground)	Delta	31	Based on voltage	4-8
3	1	I1	2	V1, V3 (V2 to Ground)	Delta (Balanced)	32	Based on voltage	4-13
4	3	I1, I2, I3	3	V1, V2, V3, (Vn to Ground)	Grounded Wye	40	Based on voltage	4-9
	3	I1, I2, I3	2	V1, V3 (Vn to Ground)	Wye	42	Based on voltage	4-10
	2	I1, I2, I3	3	V1, V2, V3 (Vn to Ground)	Grounded Wye	40	Based on voltage	4-11
4	1	I1	3	V1, V2, V3 (Vn to Ground)	Grounded Wye (Balanced)	44	Based on voltage	4-12

Wiring Diagrams

Figure 4-1: 1-Phase Line-to-Neutral 2-Wire System 1 CT

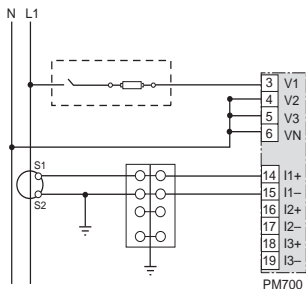

▶ Use system type 10.¹

Figure 4-2: 1-Phase Line-to-Line 2-Wire System 1 CT

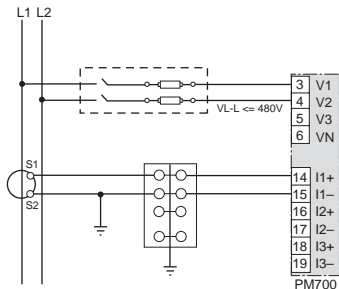

▶ Use system type 11.¹

Figure 4-3: 1-Phase Direct Voltage Connection 2 CT

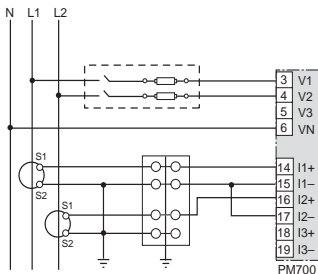

▶ Use system type 12.¹

Figure 4-4: 3-Phase 3-Wire 2 CT no PT

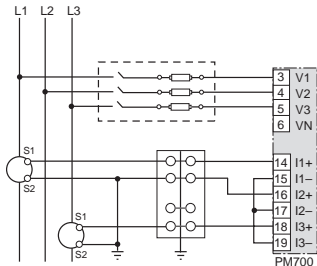

▶ Use system type 30.

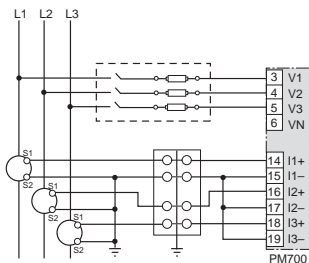
Figure 4-5: 3-Phase 3-Wire 3 CT no PT

- ▶ Use system type 31.

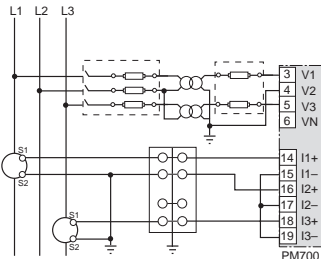
Figure 4-7: 3-Phase 3-Wire Delta Connection 2 CT 2 PT

- ▶ For an open delta PT connection with 120 V L-L secondaries, use system type 30.

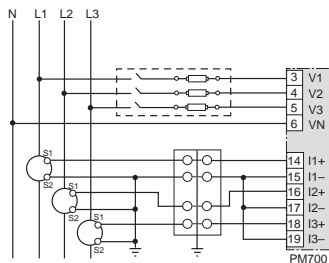
Figure 4-6: 3-Phase 4-Wire Wye Direct Voltage Input Connection 3 CT

- ▶ Use system type 40.²

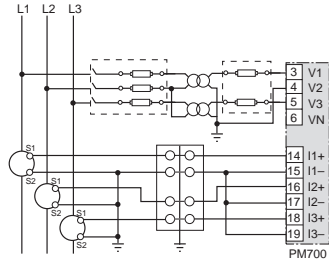
Figure 4-8: 3-Phase 3-Wire Delta Connection 3CT 2PT

- ▶ Use System type 31.³

Figure 4-9: 3-Phase 4-Wire Wye Connection 3 CT 2 PT

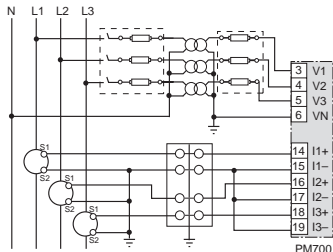

▶ Use system type 40.

Figure 4-10: 3-Phase 4-Wire Wye 3CT 2PT (for balanced voltage)

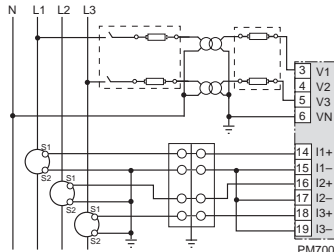

▶ Use system type 42.

Figure 4-11: 3-Phase 4-Wire Wye 3 PT 2 CT (for balanced 3-wire loads)

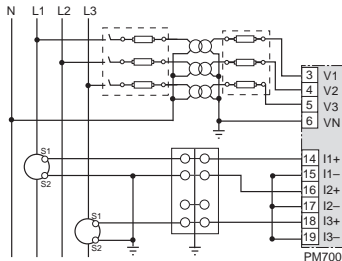

▶ Use system type 40.

Figure 4-12: Balanced 3-Phase 4-Wire 3PT 1 CT

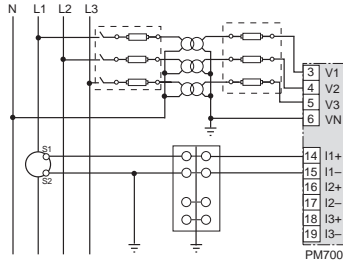

▶ Use system type 44

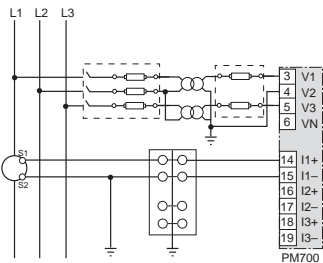
**Figure 4-13: Balanced 3-Phase 3-Wire
1 CT 2 PT**

▶ Use system type 32

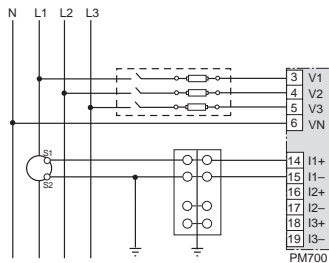
**Figure 4-14: Balanced 3-Phase 4-Wire
Direct Voltage Input
Connection 1 CT**

▶ Use system type 44

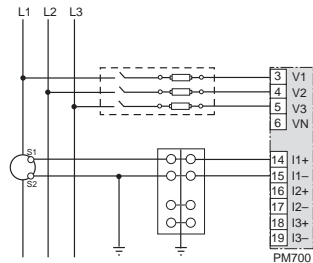
**Figure 4-15: Balanced 3-Phase 3-Wire
Direct Voltage Input
Connection 1 CT**

▶ Use system type 32

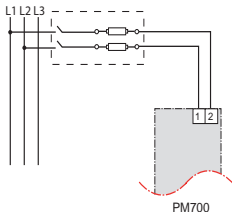
Figure 4-16: Direct Connect Control Power (Phase to Phase)

- ▶ Phase to Phase only when voltage < 415 + 10% Vac max.
- ▶ See Table 4-4 on page 22.

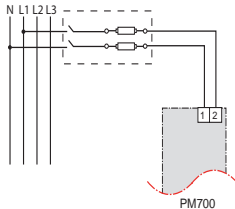
Figure 4-17: Direct Connect Control Power (Phase to Neutral)

- ▶ Phase to Neutral only when voltage < 415 + 10% Vac max.
- ▶ See Table 4-4 on page 22.

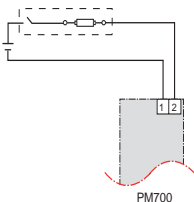
Figure 4-18: Direct Connect Control Power (DC Control Power)

- ▶ DC Control Power 100 Vdc < V < 300 Vdc
- ▶ See Table 4-4 on page 22.

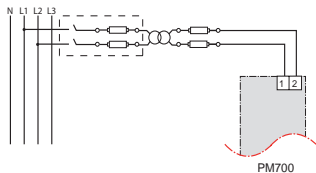
Figure 4-19: Control Power Transformer (CPT) Connection

- ▶ Control Power Transformer
120 or 240 Vac Secondary 50 Va max.
- ▶ See Table 4-4 on page 22.

¹ To avoid distortion, use parallel wires for control power and voltage inputs. Keep the fuse close to the power source.

² Use with 480Y/277 V and 208Y/120 V systems.

³ For an open delta PT connection with 120 V L-L secondaries, use system type 31.

Table 4-4: Fuse Recommendation

Control Power Source	Source Voltage (V_S)	Fuse	Fuse Amperage
CPT	$V_S \leq 125$ V	FNM or MDL	250 mA
CPT	$125 < V_S \leq 240$ V	FNQ or FNQ-R	250 mA
CPT	$240 < V_S \leq 305$ V	FNQ or FNQ-R	250 mA
Line Voltage	$V_S \leq 240$ V	FNQ-R	250 mA
Line Voltage	$V_S > 240$ V	FNQ-R	250 mA
DC	$V_S \leq 300$ V	LP-CC	500 mA

NOTES:

- ▶ See Figure 4-16 to Figure 4-19 on page 21.
- ▶ Over current protection should be located as close to the device as possible.
- ▶ For selecting fuses and circuit breakers other than those listed above, use the following criteria:
 - Over current protection should be rated as listed above.
 - Current interrupt capacity should be selected based on the installation category and fault current capability.
 - Over current protection should be selected with a time delay.
 - The voltage rating should be based on the input voltage applied.
 - If a 0.25 A fuse is not available with the required fault current capability, use a fuse rated at a maximum of 0.5 A.

Pulse Output Capabilities (PM700P)

Solid-state Pulse Output

There are two solid-state KY outputs. One is dedicated to kWh and the other is dedicated to kVARh.

Figure 4–1: Solid-state Outputs

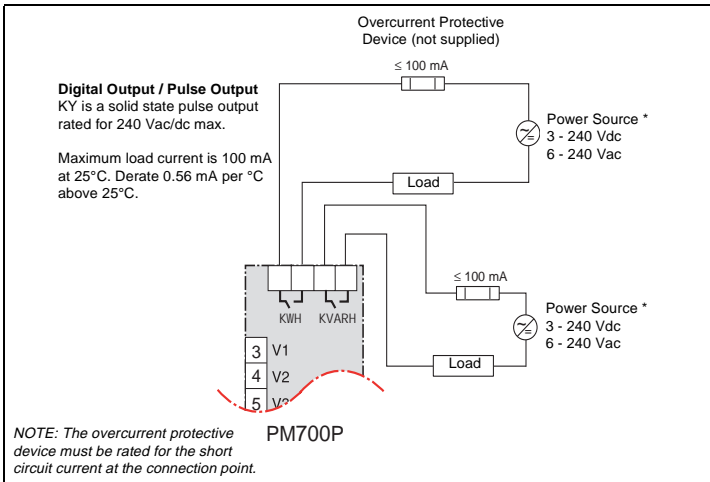

*The power source should not be a safety extra low voltage (SELV) circuit. Pulse outputs are not SELV rated.

Communications Capabilities (PM710)

Table 5–1: RS-485 Communications Distances

Baud Rate	Maximum Communication Distances 1 to 32 Devices	
	Feet	Meters
9600	8,000	2,438
19200	6,000	1,829

NOTE: Distances listed should be used as a guide only and cannot be guaranteed for non-POWERLOGIC devices. Refer to the master device's documentation for any additional distance limitations.

Daisy-chaining Devices to the Power Meter

The RS-485 slave port allows the power meter to be connected in a daisy chain with up to 31, 2-wire devices. In this bulletin, communications link refers to a chain of devices that are connected by a communications cable. See Figure 5–1.

Figure 5–1: Daisy-chaining 2-wire devices

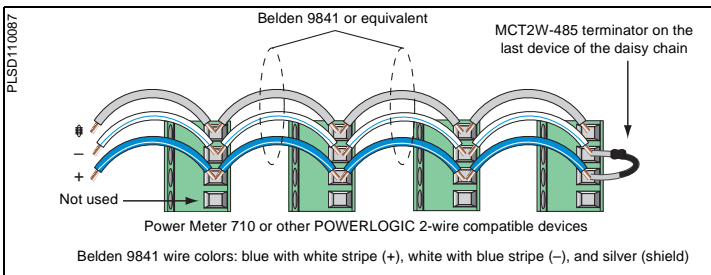

- If the power meter is the first device on the daisy chain, connect it to the host device using a RS-232 to RS-422/RS-485 converter.
- If the power meter is the last device on the daisy chain, terminate it with the terminator provided.
- See Table 5–1 for the maximum daisy-chain communications distances for 2-wire devices.
- The terminal's voltage and current ratings are compliant with the requirements of the EIA RS-485 communications standard.

Operating the Display

The power meter is equipped with a large, back-lit LCD display. It can display up to five lines of information plus a sixth row of menu options. Figure 6–1 shows the different parts of the power meter.





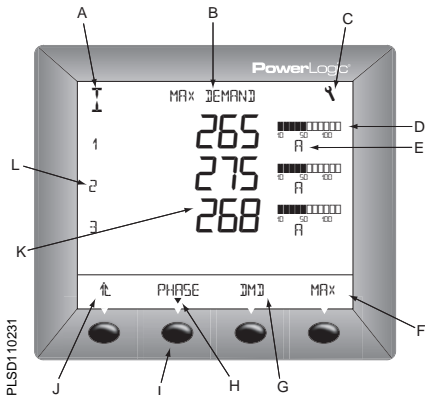

Figure 6–1: Power Meter Display

- A. Type of measurement
- B. Screen Title
- C. Maintenance icon
- D. Bar Chart (%)
- E. Units
- F. Display more menu items
- G. Menu item
- H. Selected menu indicator
- I. Button
- J. Return to previous menu
- K. Values
- L. Phase



How the Buttons Work

Table 6-1: Button Symbols

Navigation	
	View more menu items on the current level.
	Return to the previous menu level.
	Indicates the menu item is selected and there are no menu levels below the current level.
Change Values	
	Change values or scroll through the available options. When the end of a range is reached, pressing + again returns to the first value or option.
	Select the next number of a series.
	Move to the next editable field or exits the screen if the last editable field is selected.

NOTE:

- Each time you read “press” in this manual, press and release the appropriate button beneath a menu item. For example, if you are asked to “Press PHASE,” you would press and release the button below the PHASE menu item.
- Changes are automatically saved.

Menu Overview

Figure 6-2 on page 29 shows the menu items of the first two levels of the power meter. Level 1 contains all of the menu items available on the first screen of the power meter. Selecting a Level 1 menu item takes you to the next screen level containing the Level 2 menu items.

NOTE: The  is used to scroll through all menu items on a level.

Figure 6–2: Abbreviated List of IEC Power Meter Menu Items



Set Up the Power Meter

To begin power meter setup, do the following:

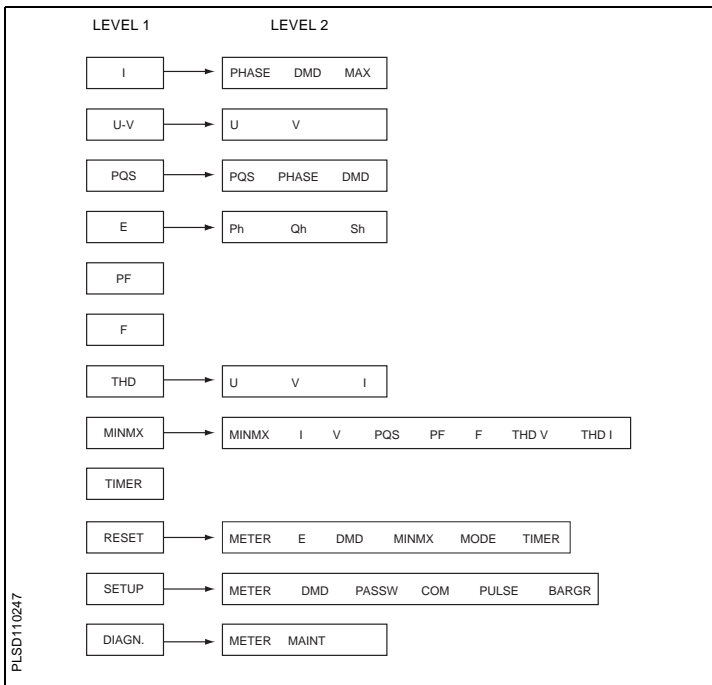
1. Press \rightarrow until you see SETUP.
2. Press SETUP.
3. Enter your password.

NOTE: The default password is 00000.

Set Up CTs

1. Press \rightarrow until METER is visible.
2. Press METER.
3. Press CT.
4. Enter the PRIM CT (primary CT) number: 1 to 32762.
5. Press OK.
6. Enter the SECON. CT (secondary CT) number: 1 or 5.
7. Press OK.
8. Press \uparrow to return to the SETUP MODE screen.



PLSD110106

Set Up PTs

1. Press \rightarrow until METER is visible.
2. Press METER.
3. Press PT.
4. Select the SCALE value: x1, x10, x100, NO PT (for direct connect).
5. Press OK.
6. Enter the PRIM (primary) value.
7. Press OK.
8. Enter the SEC. (secondary) value.
9. Press OK.
10. Press \uparrow to return to the SETUP MODE screen.

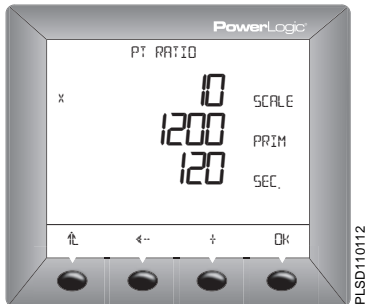

Set Up the System Frequency

1. Press \rightarrow until METER is visible.
2. Press METER.
3. Press \rightarrow until F (system frequency) is visible.
4. Press F.
5. Select the frequency: 50 Hz or 60 Hz.
6. Press OK.
7. Press \uparrow to return to the SETUP MODE screen.

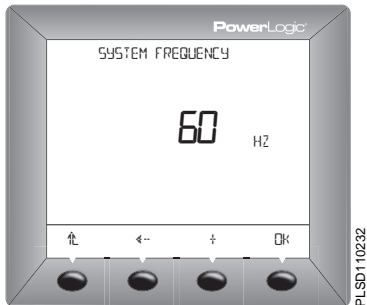

Set Up the Meter System Type

1. Press \rightarrow until METER is visible.
2. Press METER.
3. Press \rightarrow until SYS (system type) is visible.
4. Press SYS.
5. Select the SYS (system type):
10, 11, 12, 30, 31, 32, 40, 42,
44.
6. Press OK.
7. Press \uparrow to return to the
SETUP MODE screen.

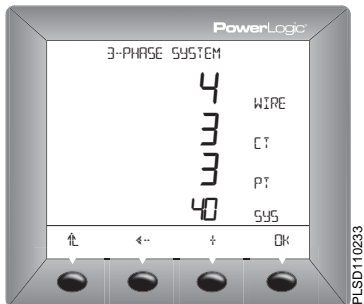

Set Up Demand Current

1. Press \rightarrow until DMD (demand) is visible.
2. Press DMD.
3. Press I (current).
4. Enter the MIN (demand interval in minutes): 1 to 60.
5. Press OK.
6. Press \uparrow to return to the
SETUP MODE screen.

NOTE: The calculation method used is Thermal.

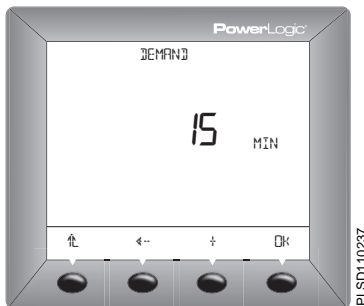

Set Up PQS Demand

1. Press \leftarrow until DMD (demand) is visible.
2. Press DMD.
3. Press PQS (real, reactive, apparent power).
4. Enter the MIN (interval in minutes): 0 to 60.
5. Enter the SUB-I (number of subintervals): 1 to 60
6. Press OK.
7. Press \uparrow to return to the SETUP MODE screen.

NOTE: The calculation method used for SUB-I is as follows:

0 = sliding block

1 = block

>1 = rolling block (The SUB-I value must divide evenly into the MIN value. For example, if MIN is 15, SUB-I can be 3, 5, or 15. If you selected 3, you would have 3 subintervals at 5 minutes each.)

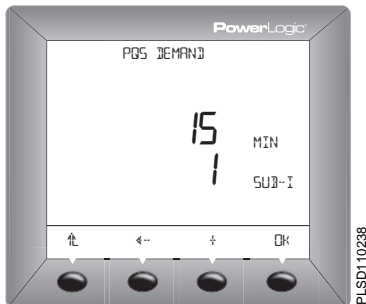

PLSD110238

Set Up the Passwords

1. Press \rightarrow until PASSW (password) is visible.
2. Press PASSW.
3. Enter the SETUP password.
4. Press OK.
5. Enter the RESET (password to reset the power meter) password.
6. Press OK to return to the SETUP MODE screen.

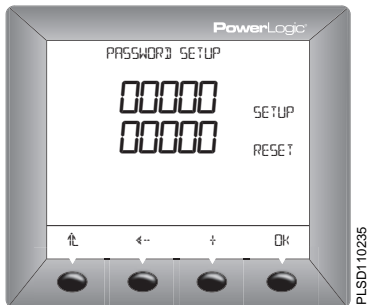

PLSD110235

Set Up the Pulses (PM700P)

1. Press \rightarrow until PULSE is visible.
2. Press PULSE.
3. Select the MSEC (kWH pulse duration in milliseconds): 100, 300, 500, or 1000.
4. Select the kWh/P (pulse weight): 0.1, 1, 10, 100, 1000, or 10000.
5. Select the MSEC (kVARH pulse duration in milliseconds): 100, 300, 500, or 1000.
6. Select the kVARH (pulse weight): 0.1, 1, 10, 100, 1000, or 10000.
7. Press OK to return to the SETUP MODE screen.

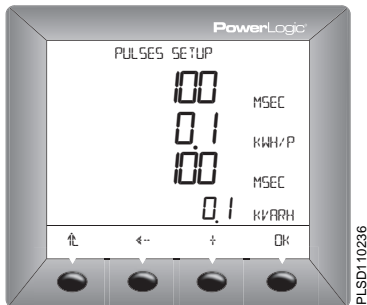

PLSD110236

Set Up the Bargraph Scale

1. Press \leftarrow until BARGR (Bargraph) is visible.
2. Press BARGR.
3. Enter the %CT (percent of CT primary to represent 100 on the bargraph).
4. Press OK.
5. Press \uparrow to return to the SETUP MODE screen.

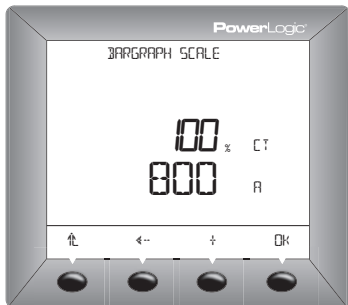

PLSD110243

Set Up Communications (PM710)

1. Press \leftarrow until COM is visible.
2. Press COM.
3. Enter the ADDR (meter address): 1 to 247.
4. Press OK.
5. Select the BAUD (baud rate): 2400, 4800, 9600 or 19200.
6. Press OK.
7. Select the parity: EVEN, ODD, NONE.
8. Press OK to return to the SETUP MODE screen.

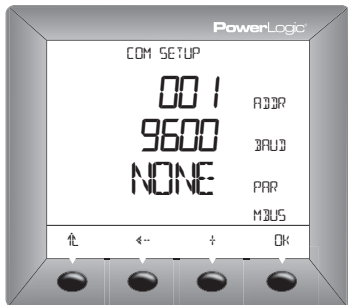

PLSD110242

Select the Operating Mode

1. From the SUMMARY screen, press \rightarrow until RESET is visible.
2. Press RESET.
3. Enter the RESET password (00000 is the default).
4. Press OK.
5. Press \rightarrow until MODE is visible.
6. Press MODE.
7. Press IEEE or IEC.
8. Press \uparrow to return to the RESET MODE screen.
9. Press \uparrow to return to the SUMMARY screen.

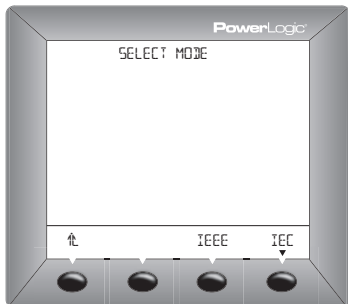

PLSD110252

Power Meter Diagnostics

View the Meter Information

1. From the SUMMARY screen, press \rightarrow until DIAGN (diagnostics) is visible.
2. Press DIAGN.
3. Press METER (meter info).
4. View the meter information (model number, firmware operating system version, firmware reset system version, and power meter serial number).
5. Press \uparrow to return to the SUMMARY screen.

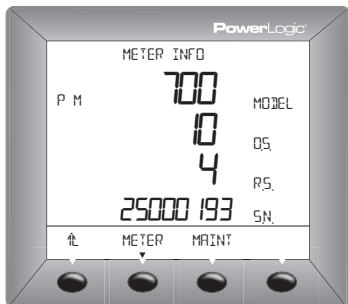

PLSD110239

Check the Health Status

1. Press **→** until **DIAGN** (diagnostics) is visible.
2. Press **DIAGN**.
3. Press **MAINT** (maintenance).
4. View the health status.
5. Press **↶** to return to the **SUMMARY** screen.

NOTE: The wrench icon and the health status code displays when a health problem is detected.

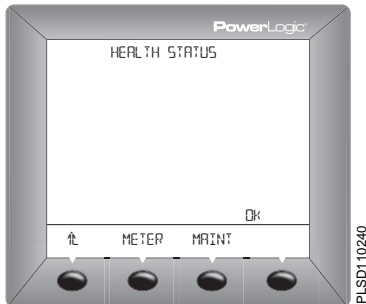

Reset the Power Meter

Restore Power Meter Default Settings

1. From the **SUMMARY** screen, press **→** until **RESET** is visible.
2. Press **RESET**.
3. Enter the **RESET** password (00000 is the default).
4. Press **OK**.
5. Press **→** until **METER** is visible.
6. Press **METER**.
7. Press **NO** or **YES**.
8. Press **↶** to return to the **SUMMARY** screen.

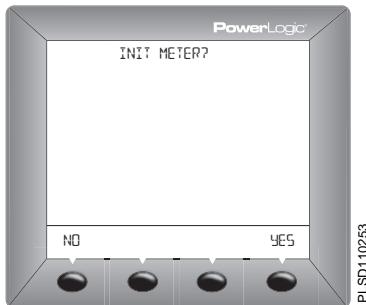

Introduction

The power meter does not contain any user-serviceable parts. If the power meter requires service, contact your local sales representative. Do not open the power meter. Opening the power meter voids the warranty.

Getting Technical Support

Please refer to the *Technical Support Contacts* provided in the power meter shipping carton for a list of support phone numbers by country.

Troubleshooting

The information in Table 8–1 describes potential problems and their possible causes. It also describes checks you can perform or possible solutions for each. After referring to this table, if you cannot resolve the problem, contact the your local Square D/Schneider Electric sales representative for assistance.

DANGER

HAZARD OF ELECTRIC SHOCK, EXPLOSION, OR ARC FLASH

- This equipment must be installed and serviced only by qualified electrical personnel.
- Turn off all power supplying this equipment before working on or inside.
- Always use a properly rated voltage sensing device to confirm that all power is off.
- Apply appropriate personal protective equipment (PPE) and follow safe electrical work practices. See NFPA 70E.
- Carefully inspect the work area for tools and objects that may have been left inside the equipment.
- Use caution while removing or installing panels so that they do not extend into the energized bus; avoid handling the panels, which could cause personal injury.

Failure to follow this instruction will result in death or serious injury

Table 8–1: Troubleshooting

Potential Problem	Possible Cause	Possible Solution
The maintenance icon is illuminated on the power meter display.	When the maintenance icon is illuminated, it indicates a potential hardware or firmware problem in the power meter.	When the maintenance icon is illuminated, go to DIAGNOSTICS > MAINTENANCE . Error messages display to indicate the reason the icon is illuminated. Note these error messages and call Technical Support or contact your local sales representative for assistance.
The display is blank after applying control power to the power meter.	The power meter may not be receiving the necessary power.	<ul style="list-style-type: none"> Verify that the power meter line (L) and neutral (N) terminals (terminals 25 and 27) are receiving the necessary power. Verify that the heartbeat LED is blinking. Check the fuse.
The data being displayed is inaccurate or not what you expect.	Incorrect setup values.	Check that the correct values have been entered for power meter setup parameters (CT and PT ratings, System Type, Nominal Frequency, and so on). See "Set Up the Power Meter" on page 31 for setup instructions.
	Incorrect voltage inputs.	Check power meter voltage input terminals to verify that adequate voltage is present.
	Power meter is wired improperly.	Check that all CTs and PTs are connected correctly (proper polarity is observed) and that they are energized. Check shorting terminals. See "Wiring Diagrams" on page 17. Initiate a wiring check from the power meter display.
Cannot communicate with power meter from a remote personal computer.	Power meter address is incorrect.	Check to see that the power meter is correctly addressed. See "Set Up Communications (PM710)" on page 36 for instructions.
	Power meter baud rate is incorrect.	Verify that the baud rate of the power meter matches the baud rate of all other devices on its communications link. See "Set Up Communications (PM710)" on page 36 for instructions.
	Communications lines are improperly connected.	Verify the power meter communications connections. Refer to the Communications chapter for instructions.
	Communications lines are improperly terminated.	Check to see that a multipoint communications terminator is properly installed. See Figure 5–1 on page 25 for instructions.
	Incorrect route statement to power meter.	Check the route statement. Refer to the SMS online help for instructions on defining route statements.

Power Meter Specifications

Table A-1: Specifications

Electrical Characteristics			
Type of measurement		True rms up to the 15th harmonic on three-phase AC system (3P, 3P + N) 32 samples per cycle	
Measurement Accuracy	Current and Voltage	0.5% of reading from 20% to 120%	
	Power	1%	
	Frequency	±0.01 Hz from 45 to 65 Hz	
	Real Energy	IEC 62053-21 Class 1	
	Reactive Energy	IEC 62053-23 Class 2	
Data update rate		1 s	
Input-voltage	Measured voltage	10 to 480 V AC (direct L-L) 10 to 277 V AC (direct L-N) 0 to 1.6 MV AC (with external VT)	
	Metering over-range	1.2 Un	
	Impedance	2 MΩ (L-L) / 1 MΩ (L-N)	
	Frequency range	45 to 65 Hz	
Input-current	CT ratings	Primary	Adjustable from 5A to 32767 A
		Secondary	5 A starting at 10 mA
	Measurement input range		0 to 6 A
	Permissible overload		10 A continuous 50 A for 10 seconds per hour 120 A for 1 second per hour
	Impedance		< 0.1 2 Ω
	Load		< 0.15 VA
Control Power	AC		115 to 415 ±10% V AC, 5 VA; 50 to 60 Hz
	DC		125 to 250 ±20% V DC, 3W
	Ride-through time		100 ms at 120 V AC
Output	Pulse output (PM700P)		Static output 240 ±10 % V AC, 100 mA max. @ 25 °C (derate 0.56 mA per °C above 25°C), 2.41 kV rms isolation, 30Ω on-resistance @ 100 mA

Table A-1: Specifications

Mechanical Characteristics		
Weight	0.37 kg	
IP degree of protection (IEC 60529)	Designed to IP52 front display, IP30 meter body	
Dimensions	96 x 96 x 88 mm (meter with display) 96 x 96 x 50 mm (behind mounting surface)	
Environmental Characteristics		
Operating temperature	Meter	-0 °C to +60 °C
	Display	-10 °C to +50 °C
Storage temperature	Meter + display	-40 °C to +85 °C
Humidity rating		5 to 95 % RH at 50 °C (non-condensing)
Pollution degree		2
Metering category (voltage inputs and control power)		CAT III, for distribution systems up to 277 V L-N / 480 V AC L-L
Dielectric withstand		As per EN61010, UL508 Double insulated front panel display
Altitude		3000 m
Electromagnetic Compatibility		
Electrostatic discharge		Level III (IEC 61000-4-2)
Immunity to radiated fields		Level III (IEC 61000-4-3)
Immunity to fast transients		Level III (IEC 61000-4-4)
Immunity to impulse waves		Level III (IEC 61000-4-5)
Conducted immunity		Level III (IEC 61000-4-6)
Immunity to magnetic fields		Level III (IEC 61000-4-8)
Immunity to voltage dips		Level III (IEC 61000-4-11)
Conducted and radiated emissions		CE commercial environment/FCC part 15 class B EN55011
Harmonics		IEC 61000-3-2
Flicker emissions		IEC 61000-3-3
Safety		
Europe		CE, as per IEC 61010-1
U.S. and Canada		UL508

Table A-1: Specifications

Communications	
RS485 port (PM710)	2-wire, up to 19200 bauds, Modbus RTU
Firmware Characteristics	
Minimum/maximum	Worst minimum and maximum of three phases with phase indication for Voltages, Currents, and THD. Minimum and maximum values for power factor, power (P, Q, S) and frequency
Firmware update	Update via the communication port
Display Characteristics	
Dimensions 73 x 69 mm	Back-lit green LCD (6 lines total, 4 concurrent values)

Glossary

accumulated energy—energy can accumulate in either signed or unsigned (absolute) mode. In signed mode, the direction of power flow is considered and the accumulated energy magnitude may increase and decrease. In absolute mode, energy accumulates as a positive regardless of the power flow direction.

baud rate—specifies how fast data is transmitted across a network port.

block interval demand—power demand calculation method for a block of time and includes three ways to apply calculating to that block of time using the sliding block, fixed block, or rolling block method.

communications link—a chain of devices connected by a communications cable to a communications port.

current transformer (CT)—current transformer for current inputs.

demand—average value of a quantity, such as power, over a specified interval of time.

device address—defines where the power meter resides in the power monitoring system.

event—the occurrence of an alarm condition, such as *Undervoltage Phase A*, configured in the power meter.

firmware—operating system within the power meter

fixed block—an interval selected from 1 to 60 minutes (in 1-minute increments). The power meter calculates and updates the demand at the end of each interval.

float—a 32-bit floating point value returned by a register (see Appendix C —Register List on page 51). The upper 16-bits are in the lowest-numbered register pair. For example, in the register 4010/11, 4010 contains the upper 16-bits while 4011 contains the lower 16-bits.

frequency—number of cycles in one second.

line-to-line voltages—measurement of the rms line-to-line voltages of the circuit.

line-to-neutral voltages—measurement of the rms line-to-neutral voltages of the circuit.

maximum demand current—highest demand current measured in amperes since the last reset of demand.

maximum demand real power—highest demand real power measured since the last reset of demand.

maximum demand voltage—highest demand voltage measured since the last reset of demand voltage.

maximum demand—highest demand measured since the last reset of peak demand.

maximum value—highest value recorded of the instantaneous quantity such as Phase A Current, Phase A Voltage, etc., since the last reset of the minimums and maximums.

minimum value—lowest value recorded of the instantaneous quantity such as Phase A Current, Phase A Voltage, etc., since the last reset of the minimums and maximums.

nominal—typical or average.

parity—refers to binary numbers sent over the communications link. An extra bit is added so that the number of ones in the binary number is either even or odd, depending on your configuration). Used to detect errors in the transmission of data.

partial interval demand—calculation of energy thus far in a present interval. Equal to energy accumulated thus far in the interval divided by the length of the complete interval.

phase currents (rms)—measurement in amperes of the rms current for each of the three phases of the circuit. See also *maximum value*.

phase rotation—phase rotations refers to the order in which the instantaneous values of the voltages or currents of the system reach their maximum positive values. Two phase rotations are possible: A-B-C or A-C-B.

potential transformer (PT)—also known as a voltage transformer

power factor (PF)—true power factor is the ratio of real power to apparent power using the complete harmonic content of real and apparent power. Calculated by dividing watts by volt amperes. Power factor is the difference between the total power your utility delivers and the portion of total power that does useful work. Power factor is the degree to which voltage and current to a load are out of phase.

real power—calculation of the real power (3-phase total and per-phase real power calculated) to obtain kilowatts.

rms—root mean square. Power meters are true rms sensing devices.

rolling block—a selected interval and subinterval that the power meter uses for demand calculation. The subinterval must divide evenly into the interval. Demand is updated at each subinterval, and the power meter displays the demand value for the last completed interval.

scale factor—multipliers that the power meter uses to make values fit into the register where information is stored.

safety extra low voltage (SELV) circuit—a SELV circuit is expected to always be below a hazardous voltage level.

short integer—a signed 16-bit integer (see Appendix C —Register List on page 51).

sliding block—an interval selected from 1 to 60 minutes (in 1-minute increments). If the interval is between 1 and 15 minutes, the demand calculation updates every 15 seconds. If the interval is between 16 and 60 minutes, the demand calculation updates every 60 seconds. The power meter displays the demand value for the last completed interval.

SMS—see System Manager Software.

System Manager Software (SMS)—software designed by POWERLOGIC for use in evaluating power monitoring and control data.

system type—a unique code assigned to each type of system wiring configuration of the power meter.

thermal demand—demand calculation based on thermal response.

Total Harmonic Distortion (THD or thd)—indicates the degree to which the voltage or current signal is distorted in a circuit.

total power factor—see *power factor*.

true power factor—see *power factor*.

unsigned integer—an unsigned 16-bit integer (see Appendix C —Register List on page 51).

unsigned long integer—an unsigned 32-bit value returned by a register (see Appendix C —Register List on page 51). The upper 16-bits are in the lowest-numbered register pair. For example, in the register pair 4010 and 4011, 4010 contains the upper 16-bits while 4011 contains the lower 16-bits.

VAR—volt ampere reactive.

Abbreviations and Symbols

A—Ampere

ADDR—Power meter address

BARGR—Bargraph

COM—Communications

CPT—Control Power Transformer

CT—see *current transformer* on page 45

DMD—Demand

F—Frequency

I—Current

IMAX—Current maximum demand

kVA—Kilovolt-Ampere

kVAD—Kilovolt-Ampere demand

kVAR—Kilovolt-Ampere reactive

kVARD—Kilovolt-Ampere reactive demand

kVARH—Kilovolt-Ampere reactive hour

kW—Kilowatt

kWD—Kilowatt demand

kWH/P—Kilowatthours per pulse

KWMAX—Kilowatt maximum demand

MAINT—Maintenance screen

MBUS—MODBUS

MIN—Minimum

MINS—Minutes

MINMX—Minimum and maximum values

MSEC—Milliseconds

MVAh—Megavolt ampere hour

MVARh—Megavolt ampere reactive hour

MWh—Megawatt hour

O.S.—Operating System (firmware version)

P—Real power

PAR—Parity

PASSW—Password

Pd—Real power demand

PF—Power factor

Ph—Real energy

PM—Power meter

PQS	—Real, reactive, apparent power
PQsd	—Real, reactive, apparent power demand
PRIM	—Primary
PT	—Number of voltage connections (see <i>potential transformer</i> on page 46)
PULSE	—Pulse
Q	—Reactive power
Qd	—Reactive power demand
Qh	—Reactive energy
R.S.	—Firmware reset system version
S	—Apparent power
S.N.	—Power meter serial number
SCALE	—see <i>scale factor</i> on page 46
Sd	—Apparent power demand
SECON	—Secondary
SEC	—Secondary
Sh	—Apparent Energy
SUB-I	—Subinterval
SYS	—System Manager™ software (SMS) system type (ID)
U	—Voltage line to line
V	—Voltage
VMAX	—Maximum voltage
VMIN	—Minimum voltage

Register List

Register	Units	Scale Factor	Range	Description
4000 to 4001	kWh	See register 4108	0 to 0xFFFFFFFF	Real Energy Consumption
4002 to 4003	kVAh	See register 4108	0 to 0xFFFFFFFF	Apparent Energy Consumption
4004 to 4005	kVARh	See register 4108	0 to 0xFFFFFFFF	Reactive Energy Consumption
4006	kW	See register 4107	0 to 32767	Total Real Power
4007	kVA	See register 4107	0 to 32767	Total Apparent Power
4008	kVAR	See register 4107	0 to 32767	Total Reactive Power
4009	—	0.0001	0 to 10000	Total Power Factor
4010	Volt	See register 4106	0 to 32767	Voltage, L-L, ave of 3 phases
4011	Volt	See register 4106	0 to 32767	Voltage, L-N, ave of 3 phases
4012	Amp	See register 4105	0 to 32767	Current, average of 3 phases
4013	Hz	0.01	4500 to 6500	Frequency (derived from Phase A)
4014	kW	See register 4107	0 to 32767	Total Real Power Present Demand
4015	kVA	See register 4107	0 to 32767	Total Apparent Power Present Demand
4016	kVAR	See register 4107	0 to 32767	Total Reactive Power Present Demand
4017	kW	See register 4107	0 to 32767	Total Real Power Max Demand
4018	kVA	See register 4107	0 to 32767	Total Apparent Power Max Demand
4019	kVAR	See register 4107	0 to 32767	Total Reactive Power Max Demand
4020	Amp	See register 4105	0 to 32767	Current, Instantaneous, Phase A
4021	Amp	See register 4105	0 to 32767	Current, Instantaneous, Phase B
4022	Amp	See register 4105	0 to 32767	Current, Instantaneous, Phase C
4023	Amp	See register 4105	0 to 32767	Current, Instantaneous, Neutral
4024	Amp	See register 4105	0 to 32767	Current, Present Demand, Phase A
4025	Amp	See register 4105	0 to 32767	Current, Present Demand, Phase B
4026	Amp	See register 4105	0 to 32767	Current, Present Demand, Phase C
4027	Amp	See register 4105	0 to 32767	Current, Max Demand, Phase A

- Registers 4000 – 4005, 7002, and 7003 are unsigned long integer values
- Registers 4006 – 4104, 4109 – 7001, and 7004 – 7162 are unsigned integer values
- Registers 4105 – 4108 are signed integer values
- All registers are Read-only except for 4117 – 4128 and 7015 – 7162.

Appendix C — Register List

Register List

63230-501-201A3
4/2004

Register	Units	Scale Factor	Range	Description
4028	Amp	See register 4105	0 to 32767	Current, Max Demand, Phase B
4029	Amp	See register 4105	0 to 32767	Current, Max Demand, Phase C
4030	Volt	See register 4106	0 to 32767	Voltage, Phase A-B
4031	Volt	See register 4106	0 to 32767	Voltage, Phase B-C
4032	Volt	See register 4106	0 to 32767	Voltage, Phase A-C
4033	Volt	See register 4106	0 to 32767	Voltage, Phase A-N
4034	Volt	See register 4106	0 to 32767	Voltage, Phase B-N
4035	Volt	See register 4106	0 to 32767	Voltage, Phase C-N
4036	kW	See register 4107	0 to 32767	Real Power, Phase A
4037	kW	See register 4107	0 to 32767	Real Power, Phase B
4038	kW	See register 4107	0 to 32767	Real Power, Phase C
4039	kVA	See register 4107	0 to 32767	Apparent Power, Phase A
4040	kVA	See register 4107	0 to 32767	Apparent Power, Phase B
4041	kVA	See register 4107	0 to 32767	Apparent Power, Phase C
4042	kVAR	See register 4107	0 to 32767	Reactive Power, Phase A
4043	kVAR	See register 4107	0 to 32767	Reactive Power, Phase B
4044	kVAR	See register 4107	0 to 32767	Reactive Power, Phase C
4045	%	0.1	0 to 10000	THD, Current, Phase A
4046	%	0.1	0 to 10000	THD, Current, Phase B
4047	%	0.1	0 to 10000	THD, Current, Phase C
4048	%	0.1	0 to 10000	THD, Current, Neutral (future use)
4049	%	0.1	0 to 10000	THD, Voltage A-N
4050	%	0.1	0 to 10000	THD, Voltage B-N
4051	%	0.1	0 to 10000	THD, Voltage C-N
4052	%	0.1	0 to 10000	THD, Voltage A-B
4053	%	0.1	0 to 10000	THD, Voltage B-C
4054	%	0.1	0 to 10000	THD, Voltage A-C
4055	kW	See register 4107	0 to 32767	Total Real Power Minimum
4056	kVA	See register 4107	0 to 32767	Total Apparent Power Minimum

- Registers 4000 – 4005, 7002, and 7003 are unsigned long integer values
- Registers 4006 – 4104, 4109 – 7001, and 7004 – 7162 are unsigned integer values
- Registers 4105 – 4108 are signed integer values
- All registers are Read-only except for 4117 – 4128 and 7015 – 7162.

Register	Units	Scale Factor	Range	Description
4057	kVAR	See register 4107	0 to 32767	Total Reactive Power Minimum
4058	—	0.0001	0 to 10000	Total PF Minimum
4059	—	0.01	4500 to 6500	Frequency Minimum (derived from Phase A)
4060	Amp	See register 4105	0 to 32767	Current, Phase A, Minimum
4061	Amp	See register 4105	0 to 32767	Current, Phase B, Minimum
4062	Amp	See register 4105	0 to 32767	Current, Phase C, Minimum
4063	Amp	See register 4105	0 to 32767	Current, Neutral, Minimum (future use)
4064	Volt	See register 4106	0 to 32767	Voltage, A-N, Minimum
4065	Volt	See register 4106	0 to 32767	Voltage, B-N, Minimum
4066	Volt	See register 4106	0 to 32767	Voltage, C-N, Minimum
4067	Volt	See register 4106	0 to 32767	Voltage, A-B, Minimum
4068	Volt	See register 4106	0 to 32767	Voltage, B-C, Minimum
4069	Volt	See register 4106	0 to 32767	Voltage, A-C, Minimum
4070	%	0.1	0 to 10000	THD, Current, Phase A, Minimum
4071	%	0.1	0 to 10000	THD, Current, Phase B, Minimum
4072	%	0.1	0 to 10000	THD, Current, Phase C, Minimum
4073	%	0.1	0 to 10000	THD, Current, Neutral, Minimum (future use)
4074	%	0.1	0 to 10000	THD, Voltage A-N, Minimum
4075	%	0.1	0 to 10000	THD, Voltage B-N, Minimum
4076	%	0.1	0 to 10000	THD, Voltage C-N, Minimum
4077	%	0.1	0 to 10000	THD, Voltage A-B, Minimum
4078	%	0.1	0 to 10000	THD, Voltage B-C, Minimum
4079	%	0.1	0 to 10000	THD, Voltage A-C, Minimum
4080	kW	See register 4107	0 to 32767	Total Real Power Maximum
4081	kVA	See register 4107	0 to 32767	Total Apparent Power Maximum
4082	kVAR	See register 4107	0 to 32767	Total Reactive Power Maximum
4083	—	0.0001	0 to 10000	Total PF Maximum
4084	—	0.01	4500 to 6500	Frequency Maximum (derived from Phase A)
4085	Amp	See register 4105	0 to 32767	Current, Phase A, Maximum

- Registers 4000 – 4005, 7002, and 7003 are unsigned long integer values
- Registers 4006 – 4104, 4109 – 7001, and 7004 – 7162 are unsigned integer values
- Registers 4105 – 4108 are signed integer values
- All registers are Read-only except for 4117 – 4128 and 7015 – 7162.

Appendix C — Register List

Register List

63230-501-201A3
4/2004

Register	Units	Scale Factor	Range	Description
4086	Amp	See register 4105	0 to 32767	Current, Phase B, Maximum
4087	Amp	See register 4105	0 to 32767	Current, Phase C, Maximum
4088	Amp	See register 4105	0 to 32767	Current, Neutral, Maximum (future use)
4089	Volt	See register 4106	0 to 32767	Voltage, A-N, Maximum
4090	Volt	See register 4106	0 to 32767	Voltage, B-N, Maximum
4091	Volt	See register 4106	0 to 32767	Voltage, C-N, Maximum
4092	Volt	See register 4106	0 to 32767	Voltage, A-B, Maximum
4093	Volt	See register 4106	0 to 32767	Voltage, B-C, Maximum
4094	Volt	See register 4106	0 to 32767	Voltage, A-C, Maximum
4095	%	0.1	0 to 10000	THD, Current, Phase A, Maximum
4096	%	0.1	0 to 10000	THD, Current, Phase B, Maximum
4097	%	0.1	0 to 10000	THD, Current, Phase C, Maximum
4098	%	0.1	0 to 10000	THD, Current, Neutral, Maximum (future use)
4099	%	0.1	0 to 10000	THD, Voltage A-N, Maximum
4100	%	0.1	0 to 10000	THD, Voltage B-N, Maximum
4101	%	0.1	0 to 10000	THD, Voltage C-N, Maximum
4102	%	0.1	0 to 10000	THD, Voltage A-B, Maximum
4103	%	0.1	0 to 10000	THD, Voltage B-C, Maximum
4104	%	0.1	0 to 10000	THD, Voltage A-C, Maximum
4105	—	-4 = 0.0001 -3 = 0.001 -2 = 0.01 -1 = 0.1 0 = 1.0 1 = 10.0 2 = 100.0 3 = 1000.0 4 = 10000.0		Scale Factor 1 (current)

- Registers 4000 – 4005, 7002, and 7003 are unsigned long integer values
- Registers 4006 – 4104, 4109 – 7001, and 7004 – 7162 are unsigned integer values
- Registers 4105 – 4108 are signed integer values
- All registers are Read-only except for 4117 – 4128 and 7015 – 7162.

Register	Units	Scale Factor	Range	Description
4106	—	-4 = 0.0001 -3 = 0.001 -2 = 0.01 -1 = 0.1 0 = 1.0 1 = 10.0 2 = 100.0 3 = 1000.0 4 = 10000.0		Scale Factor V (voltage)
4107	—	-4 = 0.0001 -3 = 0.001 -2 = 0.01 -1 = 0.1 0 = 1.0 1 = 10.0 2 = 100.0 3 = 1000.0 4 = 10000.0		Scale Factor W (power)
4108	—	-4 = 0.0001 -3 = 0.001 -2 = 0.01 -1 = 0.1 0 = 1.0 1 = 10.0 2 = 100.0 3 = 1000.0 4 = 10000.0		Scale Factor E (energy)
4109	—	—	—	Feature Bitmap (future use, always returns zero presently)
4110	Hours	—	0 to 32767	Usage Hours
4111	Minutes	—	0 to 59	Usage Minutes

- Registers 4000 – 4005, 7002, and 7003 are unsigned long integer values
- Registers 4006 – 4104, 4109 – 7001, and 7004 – 7162 are unsigned integer values
- Registers 4105 – 4108 are signed integer values
- All registers are Read-only except for 4117 – 4128 and 7015 – 7162.

Register	Units	Scale Factor	Range	Description
4112	—	—	—	Error Bitmap: bit 0: Phase A Voltage out of range bit 1: Phase B Voltage out of range bit 2: Phase C Voltage out of range bit 3: Phase A Current out of range bit 4: Phase B Current out of range bit 5: Phase C Current out of range bit 6: Frequency out of range or insufficient voltage on Phase A to determine frequency bit 7-15: Reserved for future use
4113	—	—	—	Reserved, always returns 0
4114	—	—	—	Reserved, always returns 0
4115	—	—	—	Reserved, always returns 0
4116	—	—	—	Reserved, always returns 0
4117	Minutes	—	1 to 60	Thermal Demand Interval
4118	Minutes	—	1 to 60	Power Block Demand Interval
4119	—	—	1 to 60	Power Block Demand Sub-Intervals If set to 0, a subinterval of 15 seconds is used for Demand Intervals less than or equal to 15 minutes, or 60 seconds for intervals greater than 15 minutes.
4120	—	—	1 to 32767	CT Ratio – Primary
4121	—	—	1 or 5	CT Ratio - Secondary
4122	—	—	1 to 32767	PT Ratio - Primary
4123	—	—	0,1,10,100	PT Ratio - Scale (0 = No PT)
4124	—	—	100,110,115,120	PT Ratio – Secondary
4125	Hz	—	50 or 60	Service Frequency

- Registers 4000 – 4005, 7002, and 7003 are unsigned long integer values
- Registers 4006 – 4104, 4109 – 7001, and 7004 – 7162 are unsigned integer values
- Registers 4105 – 4108 are signed integer values
- All registers are Read-only except for 4117 – 4128 and 7015 – 7162.

Register	Units	Scale Factor	Range	Description
4126	—	—	N/A	Reset <ul style="list-style-type: none"> • Write 14255 to reset all Min/Max Values. • Write 30078 to clear all Energy Accumulators. • Write 21212 to reset Peak Demand values to Present Demand Values. • Write 10001 to clear the Usage Timers. • Read always returns 0.
4127	—	—	10,11,12,30, 31, 32, 40, 42, 44	System Type
4128	—	—	0,1	Units: 0 = IEC, 1 = IEEE units
7000	—	—	0 to 32767	Firmware Version, Reset System
7001	—	—	—	Firmware Version, Operating System
7002/03	—	—	—	Serial Number (date/time of mfg in UTC)
7004	—	—	15165	Device ID = 15165
7005	—	—	1 to 247	Modbus Address
7006	—	—	2400,4800, 9600,19200	Baudrate
7007	—	—	—	Password (always returns 0)
7008	—	—	—	Selftest (always returns 0)
7010	—	—	—	Reserved, always returns 0
7011	—	—	—	Reserved, always returns 0
7012	—	—	—	Reserved, always returns 0
7013	—	—	—	Reserved, always returns 0
7014	—	—	—	Reserved, always returns 0

- Registers 4000 – 4005, 7002, and 7003 are unsigned long integer values
- Registers 4006 – 4104, 4109 – 7001, and 7004 – 7162 are unsigned integer values
- Registers 4105 – 4108 are signed integer values
- All registers are Read-only except for 4117 – 4128 and 7015 – 7162.

Supported MODBUS Commands

Command	Description
0x03	Read holding registers
0x04	Read input registers
0x06	Preset single registers
0x10	Preset multiple registers
0x11	Report ID Return String byte 1: 0x11 byte 2: number of bytes following without crc byte 3: ID byte = 250 byte 4: status = 0xFF bytes 5+: ID string = PM710 Power Meter last 2 bytes: CRC
0x2B	Read device identification, BASIC implementation (0x00, 0x01, 0x02 data), conformity level 1, Object Values 0x01: If register 4128 is 0, then "Merlin Gerin. If register 4128 is 1, then "Square D" 0x02: "PM710" 0x03: "Vxx.yyy" where xx.yyy is the OS version number. This is the reformatted version of register 7001. If the value for register 7001 is 12345, then the 0x03 data would be "V12.345"

- A**
 - address
 - device address 40
- B**
 - bargraph scale
 - setup 36
 - baud rate 40
 - button
 - symbols 28
 - buttons
 - how to use 28
- C**
 - communication
 - characteristics 7
 - communications
 - capabilities 25
 - daisy-chaining devices 25
 - functions 7
 - problems with PC communication 40
 - settings 7
 - setup 36
 - communications distances 25
 - connections
 - wiring 15
 - contacting technical support 39
 - CT
 - setup 31
- D**
 - demand
 - setup 33
 - values 6
 - dimensions
 - power meter 11
 - display
 - operation 27
- E**
 - energy
 - values 6
- F**
 - fuse recommendations 22
- G**
 - getting technical support 39
- H**
 - health status 38
- I**
 - IEC 37
 - IEEE 37
 - instantaneous rms
 - values 6
- M**
 - maintenance
 - maintenance icon 40
 - of power meter 39
 - maximum demand
 - values 6
 - maximum values 7
 - menu
 - list of menu items 29
 - overview 28
 - menu modes 6
 - meter information 37
 - minimum values 7
 - MODBUS 7
 - mounting
 - dimensions 11
- O**
 - operating mode
 - IEC 37
 - IEEE 37
 - operation
 - display 27
 - problems with the power meter 40
- P**
 - password
 - setup 35
 - power meter
 - box contents 5
 - characteristics 6
 - dimensions 11
 - setup 31
 - power-quality
 - values 6
 - PQS demand
 - setup 34
 - problems
 - see troubleshooting 39
 - PT
 - setup 32
 - pulse output 8
 - pulse setup 35
- R**
 - reset
 - characteristics 6
 - password 35
 - route statement 40
 - RS485 7
 - communications distances 25
- S**
 - safety precautions 9
 - setup 31
 - bargraph scale 36
 - communications 36
 - CT 31
 - demand 33
 - password 35
 - PQS demand 34
 - PT 32
 - pulse 35
 - system frequency 32
 - system type 32, 33
 - symbols
 - above buttons 28
 - wiring 15
 - system frequency
 - setup 32
 - system type
 - setup 32, 33
 - system types 16
- T**
 - technical support 39
 - thermal demand
 - values 6

V		
viewing meter information	37	
W		
wiring		troubleshooting 40
fuse recommendations	22	wiring symbols 15

Power Meter PM700

Instruction Bulletin / Manuel d'utilisation / Manual de instrucciones

Schneider Electric
Power Management Operations
295 Tech Park Drive, Suite 100
LaVergne, TN 37086
Tel: +1 (615) 287-3400
www.powerlogic.com

This product must be installed, connected, and used in compliance with prevailing standards and/or installation regulations.

As standards, specifications, and designs change from time to time, please ask for confirmation of the information given in this publication.

Ce produit doit être installé, raccordé et utilisé en respectant les normes et/ou les règlements d'installation en vigueur.

En raison de l'évolution des normes et du matériel, les caractéristiques et cotes d'encombrement données ne nous engagent qu'après confirmation par nos services.

Este producto deberá instalarse, conectarse y utilizarse en conformidad con las normas y/o los reglamentos de instalación vigentes.

Debido a la evolución constante de las normas y del material, nos comprometemos únicamente con las características y cotas de volumen previa confirmación de nuestros servicios.

Publishing: Square D Company PMO

Production: Square D Company PMO

Édition : Square D Company PMO

Production : Square D Company PMO

Editado por: Square D Company PMO

Producción: Square D Company PMO